

Telenetics

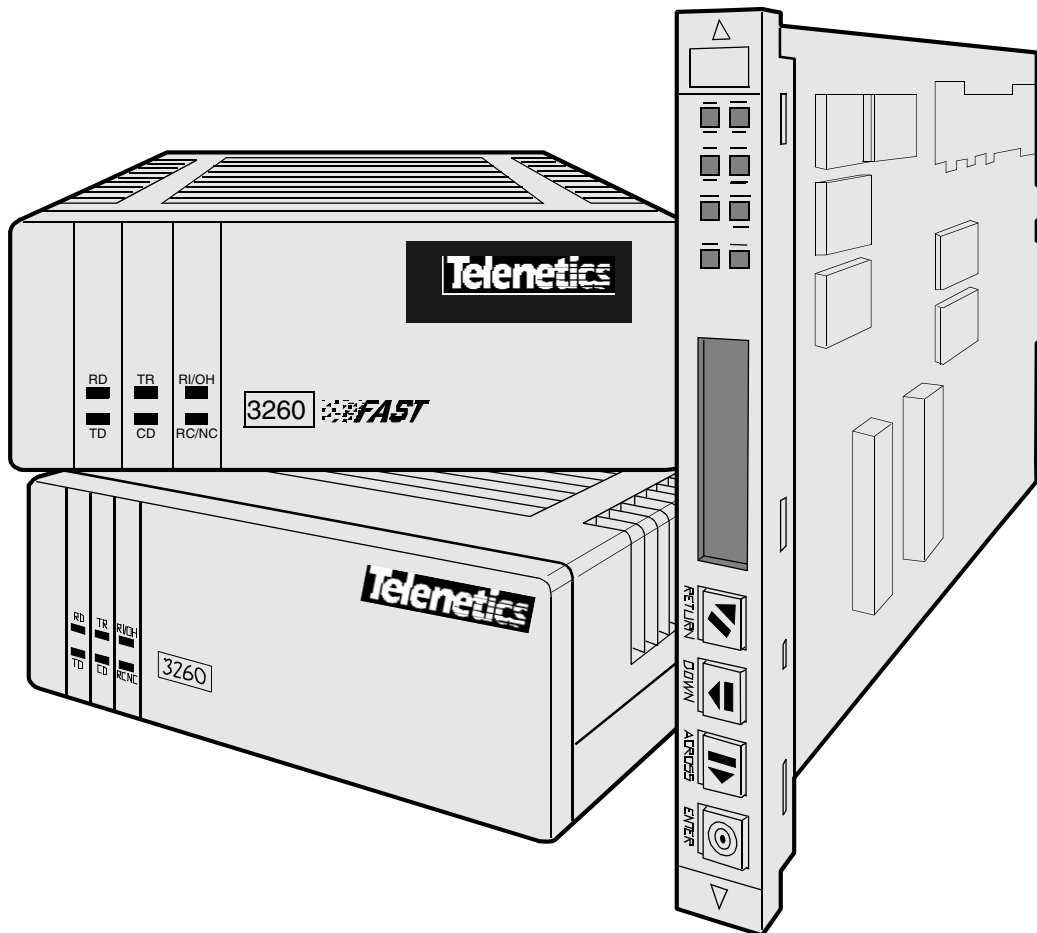

326X V.34, V.34-SDC, and V.32bis Series Modem User's Guide

Notice

©2001 Telenetics Corporation
25111 Arctic Ocean
Lake Forest, California 92630
(949) 455-4000
All rights reserved
Printed in U.S.A.

Restricted Rights Notification for U.S. Government Users

The software (including firmware) addressed in this manual is provided to the U.S. Government under agreement which grants the government the minimum “restricted rights” in the software, as defined in the Federal Acquisition Regulation (FAR) or the Defense Federal Acquisition Regulation Supplement (DFARS), whichever is applicable.

If the software is procured for use by the Department of Defense, the following legend applies:

Restricted Rights Legend

Use, duplication, or disclosure by the Government
is subject to restrictions as set forth in
subparagraph (c)(1)(ii) of the
Rights in Technical Data and Computer Software
clause at DFARS 252.227-7013.

If the software is procured for use by any U.S. Government entity other than the Department of Defense, the following notice applies:

Notice

Notwithstanding any other lease or license agreement that may pertain to, or accompany the delivery of, this computer software, the rights of the Government regarding its use, reproduction, and disclosure are as set forth in FAR 52.227-19(C).

Unpublished - rights reserved under the copyright laws of the United States.

Notice (continued)

Proprietary Material

Information and software in this document are proprietary to Telenetics Corporation (or its Suppliers) and without the express prior permission of an officer of Telenetics Corporation, may not be copied, reproduced, disclosed to others, published, or used, in whole or in part, for any purpose other than that for which it is being made available. Use of software described in this document is subject to the terms and conditions of the Telenetics Software License Agreement.

This document is for information purposes only and is subject to change without notice.

Radio Frequency Interference Regulations

This equipment has been tested and found to comply with the limits for a Class A digital device, pursuant to Part 15 of the FCC Rules. These limits are designed to provide reasonable protection against interference when the equipment is operated in a commercial environment. This equipment generates, uses, and can radiate radio frequency energy and, if not installed and used in accordance with the instruction manual, may cause harmful interference to radio communications.

Note: the 3262/63/67/68 Modem is a Class A product. In a domestic environment, this product may cause radio interference, in which case the user may be required to take adequate measures.

Changes or modifications not expressly approved by Telenetics could void the user's authority to operate the equipment.

This Class A digital apparatus meets all requirements of the Canadian Interference-Causing Equipment Regulations.

This is a Class A product. Operation of this equipment in a residential environment may cause radio interference, in which case the user may be required to take adequate measures to correct the interference at his/her own expense.

This product is CISPR 22 Class B verified under test conditions that included use of shielded DTE cables. Ferrite cylinders attached to the dial line are required for Modem 3266 (Canada). Leased line cables with 1.5 turns through a ferrite cylinder were also used. Use of different cables will invalidate verification and increase the risk of causing interference to radio and TV reception.

You can obtain the proper cables from Telenetics.

This product is **CE** marked to indicate compliance with the following European directives.

- 73/23/EEC Low Voltage Directive (Safety)
- 89/336/EEC EEC Directive

Compliance with the above directives may only be assured when the equipment is installed and operated in accordance with the instructions for its use and the purpose for which it is intended.

Products that do not bear the **CE** mark are not intended for supply or use in the European Union.

Part No. TEL-T0009, Rev A
Publication Code: DS
First Printing: January 2001

Manual is current for Release 8.0 of the 326X Series Modem.

Chapter 1, About the Modem

Introduction	1-2
Safety and Operational Notices	1-3
Operating the Modem from the Front Panel	1-4
Selecting Programmed Option Sets	1-5
Automatic Calling Interfaces (ACUs)	1-5
AT ACU	1-5
V.25bis ACU	1-5
LPDA2 ACU	1-5
Managing a Modem	1-6
Restoring Data Transmission	1-6
ITU-T V.34 Compliant Modulation Mode	1-6
Synchronous Data Compression (SDC) Feature	1-7
Automode/Multimode Feature	1-7
Remote Configuration	1-8
Error Correction and Data Compression	1-8
Security	1-8
Status Snapshots	1-8
Adaptive Rate System	1-9
Troubleshooting (V.54 and V.22bis Tests)	1-9
Country-Specific Information	1-9
NET Compliance	1-9
CE Regulatory Marking Directive (93/68/EEC)	1-9

Chapter 2, Installing the Modem

Introduction	2-2
Unpacking the Modem	2-3
Additional Equipment Required	2-4
Choosing a Site	2-4
Connecting the Modem	2-5
Rear Panel Connectors	2-5
Ferrite Cylinders	2-7
Cabling the Modem	2-11
Connecting the Modem to a Network Management System	2-13
Turning on the Modem	2-14
Automatic Self-Test	2-15
After Installing the Modem... ..	2-15

Chapter 3, Getting Started

Introduction	3-2
System Requirements for Software Upgrades	3-2
Configuring and Operating the Modem	3-2
Using the Front Panel	3-2
Navigating the Configuration Menu Tree	3-5
Setting Configuration Options from the Front Panel	3-5

Contents (continued)

Using the Modem with a Network Management System (NMS)	3-7
Using the AT Automatic Calling Unit (ACU)	3-8
Other Call Establishment Methods	3-10
V.25bis ACU for Sync or Async Applications	3-10
NetView LPDA-2 ACU for Sync Applications	3-10
Sync Dialing from an IBM AS 400	3-11
External Auto-Call Units	3-11

Chapter 4, Configuring the Modem

Overview	4-2
Communications Software Package Operating Notes	4-2
Configuring the Modem for Use with Communications Software	4-2
Operating Notes	4-3
If the Communications Software and Modem Do Not Operate... ..	4-5
Preparing for Operation	4-5
Reinitializing Memory from the Front Panel	4-5
Reinitializing Memory Using the AT&F Command	4-5
Configuration Option Sets	4-6
What is an Option Set?	4-6
Configuring an Option Set	4-10
Option Set Defaults	4-11
326X V.32bis and 326X FAST Modem Application Examples	4-16
Option Set 1—Async Calls to Central Site Using AT ACU	4-17
Option Set 2—Sync Answering Central Site Without ACU	4-18
Option Set 3—Sync Calls to Central Site, V.25bis ACU	4-18
Option Set 4—Async Answering Central Site without ACU (Models 3260/62/65/67)	4-19
Option Set 4—Synchronous Leased Line Applications with Dial Restoral (Models 3261/63/66/68)	4-20
326X FAST -SDC Modem Application Examples	4-21
SDC Pre-Operation Notes	4-21
Configuring the Modem for SDC Operation	4-22
SDC Sample Applications	4-22
Remote Access Reset	4-28
Operation	4-28
When Remote Access Reset Is Disabled	4-28

Chapter 5, Using the AT Automatic Calling Interface

Introduction	5-2
What is the Attention (AT) Command Set?	5-3
What Role Does Communications Software Play?	5-3
Using AT Commands	5-3
Entering AT Command Lines	5-3
Autobaud Feature	5-5

Contents (continued)

The Escape Sequence—(+++)	5-5
Non-Configuration AT Commands	5-6
S-Registers	5-9

Chapter 6, Troubleshooting Guide

Introduction	6-2
Troubleshooting	6-2
326X Series Modem Diagnostic Tests	6-10
Synchronous Data Compression (SDC) Testing	6-11

Appendix A, Configuration Quick Reference

Configuration Quick-Reference—Menu Trees	A-2
For More Detail	A-2
Audience and Assumptions	A-2
Performing Numeric Entry	A-37
S-Register/AT Command Cross-Reference	A-38
Dial Modifiers for Special Dialing Requirements	A-39
Result Codes	A-41
Configuring the Modem's Dual In-line Package (DIP) Switches	A-44

Appendix B, Cabling and Interface Pinouts

Introduction	B-2
EIA/TIA 232-D (Modem to Computer) Interface	B-2
ITU Recommendation V.35 Modem-to-Computer Interface	B-4
ITU Rate V.35 Modem-to-Computer Interface Pinouts	B-5
Differences, EIA/TIA 232-D and ITU Rate V.35 Interfaces	B-6
DIAL LINE, LEASE (PRIVATE) LINE, PHONE Connector Pinouts	B-6
NC (Network Control) Port Pinouts	B-7
Cabling	B-7
Cable Considerations	B-7
DTE Cable Diagnostics	B-10

Appendix C, Country-Specific Information

Introduction	C-3
Country Support	C-3
Installation Notes	C-4
Restricted Features Summary	C-5
Operating Notes	C-12
Standalone Modem Rear Panel Views	C-12
3260 Dial Only Modem	C-13
3261 Modem Rear View (Leased Line, Dial Restoral)	C-13

Contents (continued)

3265 Dial Only Modem	C-14
3266 Modem (Leased Line with Dial Restoral)	C-16
Rear Panel Interface Pinouts	C-18
Standalone Models 3260/65 and 3261/66 Interface Pinouts	C-18
Card Models 3262/67, 3263/68 Backplane Interface Pinouts	C-21
Delayed and Forbidden Lists	C-23
Australia—Delayed Call Lists	C-23
Austria—Forbidden Call Lists	C-24
Belgium—Delayed Call Lists	C-24
Finland—Delayed Call Lists	C-25
France—Delayed and Forbidden Call Lists	C-25
Hong Kong—Delayed Call Lists	C-26
Ireland—Delayed Call Lists	C-26
Netherlands—Delayed Call Lists	C-27
Norway—Delayed Call Lists	C-27
Spain—Delayed Call Lists	C-28
Other Country-Specific Information	C-28
Canada	C-28
DOC Registration and Requirements	C-28
Industry Canada Equipment Attachment Limitations	C-29
Canadian Emissions Statement	C-29
Rear Panel Pinouts	C-30
Telco Option (AT&J)	C-31
Denmark—Blind Dialing	C-32
Hong Kong and United Kingdom—BABT Regulations	C-32
Compliance with BS6328: Part 1: 1982 Section 8.3	C-32
Compliance with BS6328: Part 1: 1982 Section 8.7	C-32
Compliance with BABTSITS/82/01/C and BABT/SITS/82005S/D	C-33
Compliance with BS6305 Clause 6.2, BS6320 Clause 7.2	C-33
Ringer Equivalence Number (REN)	C-33
Compliance with BABT/SITS/83/08/A Clause 1.2	C-34
Compliance with BS6789: Section 6.1:1986 Clause 5.2	C-34
Compliance with BS6789: Section 6.1:1986 Clause 7.3.1.3	C-34
Compliance with BS6789: Section 6.1:1986 Clause 7.3.1.4	C-34
Compliance with DTI 83/009I	C-35
Compliance with BS6301	C-35
Compliance with BABT SITS 83/009 Section D	C-35
Installation of Telephone Socket	C-36
Application for Installation of Telephone Socket	C-36
U. S. A.	C-36
FCC Registration	C-36
FCC Regulations	C-37
Dial Line Jack Types	C-38
Rear Panel Pinouts	C-39
Dial and Leased Line Transmit Levels	C-41
Making Telephone-to-Modem Connections	C-41
Telco Option (AT&J)	C-42
Declaring The Jack Type	C-42
Using the Modular Nest Backplane's Busy Out Feature	C-43

Contents (continued)

Glossary

Return Procedures

Equipment Return Procedures	ret-2
Expiration of Lease	ret-2
Factory Repair	ret-2
Packaging Guidelines for Equipment Return	ret-2

Overview

The 326X product documentation set includes the *326X V.34 Series Modem Reference Card* (TEL–T0009-01).

Optionally, with a 326X Series Modem card backplane (to install a 326X card into a Modular Nest 9 or 21 enclosure), you receive the following:

- *326X Series Modem Cards* (Part No. TEL–09949)

Throughout this guide, references to the 326X Series Modem apply to 326X V.32bis, 326X V.34, and 326X-SDC Series Modems, unless stated otherwise.

326X Series Modem Family

The 326X product family consists of three **series**: V.34, V.34 SDC, and V.32bis.

<i>This Series...</i>	<i>Supports This Modulation...</i>	<i>This Maximum DCE Rate...</i>	<i>And This Maximum DTE Rate:</i>
326XFAST V.34	ITU V.34	33.6 kbps	128 kbps, asynchronous
326XFAST-SDC	ITU V.34	33.6 kbps	128 kbps, asynchronous, <i>and</i> , with proprietary compression, 128 kbps synchronous
326X	ITU V.32bis	14.4 kbps	57.6 kbps, asynchronous

IMPORTANT: *When you select a modulation mode, you must ensure that the Max Rate (AT*MX) and Min Rate (AT*MN) parameter options are within the valid range for the mode.*

Some 326XFAST-SDC models are available with a V.35-compatible interface. This unit has a DB25 connector, so a converter is required.

Product Family Model Numbers

Telenetics refers to the product family as 326X because the last digit denotes the modem **model**. Model numbers (“X”) are as follows.

<i>This Model Number...</i>	<i>Denotes:</i>
3260, 3261, 3262, 3263	Models for use in the U.S.A.
3265, 3266, 3267, 3268	Equivalent models, respectively, for international use; provided in country-specific setups
3260, 3265	Standalone models for: <ul style="list-style-type: none">• Two-wire dial operation• Two-wire leased-line operation

Using the Documentation Set (continued)

<i>This Model Number...</i>	<i>Denotes:</i>
3261, 3266	Standalone models for: <ul style="list-style-type: none">• Two-wire dial operation• Two- or four-wire leased-line operation
3262, 3267	Rack-mount dual-modem card models, equivalent to 3260 and 3265, respectively, for Modular Nest enclosure installation
3263, 3268	Rack-mount single-modem card models, equivalent to the 3266 for Modular Nest enclosure installation

Documentation Target Audience

The documentation set assumes that you are familiar with the basic concepts of data communications, that you are an operator only, and that you will not be servicing the modem hardware (other than making initial cabling connections).

Note to Programmers and System Developers

For detailed information on configuration options, equivalent AT Commands, V.25 bis Automatic-Calling Unit, NetView's LPDA-2 dialing commands, or diagnostic tests, order the *326X Series Modem Reference Guide* (Part No. TEL-09925) by contacting your Telenetics sales representative or local distributor.

How to Use the Documentation Set

Following is a description of the 326X Series Modem documentation set.

326X V.34 Series Modem Reference Card (TEL-T0009-01)

For a quick reference to AT, AT&, and AT* commands, dial modifiers, and disconnect codes, see the *326X V.34 Series Modem Reference Card*. The card also includes a menu tree of front panel options and AT command settings.

Using the Documentation Set (continued)

326X V.34 Series Modem User's Guide (TEL–T0009)

This *User's Guide* provides the information needed to install, configure, and operate the modem. Chapter outlines are as follows:

Chapter 1, About the Modem, introduces the modem's features.

Chapter 2, Installing the Modem, explains how to install and cable a modem. Quick-reference figures showing the connections to make are included.

Chapter 3, Getting Started, discusses how the modem can be used, and recommends how to configure and operate it. The chapter includes a reference guide to the rest of the documentation set for further information.

Chapter 4, Configuring the Modem, explains how to effectively configure the modem. The four preconfigured option sets are described, along with sample applications that help you choose an option set.

Chapter 5, Using the AT Automatic Calling Interface, discusses the 326X Series Modem's AT ACU. This chapter introduces:

- The ACU industry-standard (AT and AT&) commands
- The Telenetics enhanced AT command syntax (AT*).
- The AT commands that are referred to as “action” AT commands (rather than “configuration” AT commands), and S-Register functions and settings

Chapter 6, Troubleshooting Guide, is a quick reference to problems and suggestions for correcting them. This chapter assists you in isolating and correcting a problem before calling Telenetics' Customer Support Center.

Appendix A, Configuration Quick Reference, provides reference material you need to change a modem's default settings. It describes:

- Configuration options *with* and *without* AT equivalents
- Result codes (long and short forms)
- S-Registers
- Dial modifiers
- Numeric entry procedure
- The configuration menu structure

Appendix B, Cabling and Interface Pinouts, contains the pinouts for the modem's rear panel connectors and associated cables.

Appendix C, Country-Specific Information, discusses the cabling, rear panel layouts, pinouts and other modem features that are required or restricted by regulatory agencies for each country.

Using the Documentation Set (continued)

326X Series Modem Reference Guide (TEL-09925)

Available as an optional order item, the *326X Series Modem Reference Guide* is designed for users who require more detail on operating the modem's configuration options and diagnostic self-tests. Contact your Telenetics sales representative or local distributor for ordering information.

References

Refer to the following documents for more information:

- 326X, 326XFAST, and 326XFAST-SDC Series Modem Product Specification Sheets
- *EIA Application Note #562*, Appendix A (defines cable lengths in terms of DTE rates)

NetView operators should be familiar with:

- *NetView Operations Primer* (IBM Part No. SC30-3363)
- *NetView Operation Scenarios* (IBM Part No. SC30-3376)

Trademarks

The following are trademarks or registered trademarks of their respective companies or organizations:

AT is a command language used with the Smartmodem 1200 and the Smartmodem 2400/Hayes Microcomputer Products, Inc.

CompuServ / CompuServ Inc.

MNP (Microcom Networking Protocol) and Relay Gold / Microcom, Inc.

NetView and IBM / International Business Machines Corporation

Novell and NetWare / Novell, Inc

Telenet / Sprint International Communications Corporation

Tymnet / British Telecommunications

UNIX / Unix System Laboratories

Using the Documentation Set (continued)

Conventions

The following conventions are used in this manual:

- User entries appear as follows: **AT*T<CR>**
- System messages appear as follows: NO CARRIER
- A carriage return appears as follows: <CR>. It designates the Return or Enter key. It is used to complete a text entry or initiate an action from the keyboard.

Special Notices

These notices emphasize certain information in the manual. Each serves a special purpose and is displayed in the format shown.

IMPORTANT: *Important is used to emphasize any significant procedural information.*



Caution

Caution provides information that, if not followed, can result in damage to software, hardware, or data.



Warning

Warning is the most serious notice, indicating that you can be physically hurt.

Using the Documentation Set (continued)

Messages spéciaux

Les messages suivants mettent en valeur certaines informations dans le guide. Chacun d'eux remplit une fonction spéciale et est affiché dans le format indiqué.

IMPORTANT: *Important est utilisé pour souligner des informations critiques au sujet d'une procédure.*



Mise en Garde

Une mise en garde vous fournit des informations qui, si elles ne sont pas observées, peuvent se traduire par des dommages pour le logiciel, le matériel ou les données.



Avertissement

Un avertissement constitue le message le plus sérieux, indiquant que vous pouvez subir des blessures corporelles.

Besondere Hinweise

Durch die folgenden Hinweise werden bestimmte Informationen in diesem Handbuch hervorgehoben. Jeder Hinweis dient einem bestimmten Zweck und wird im dargestellten Format angezeigt.

WICHTIG: *Wichtig wird zur Betonung signifikanter Angaben zu Vorgehensweisen verwendet.*



Vorsicht

Ein Vorsichtshinweis macht Sie darauf aufmerksam, daß Nichtbefolgung zu Software-, Hardware- oder Datenschäden führen kann.



Warnung

Eine Warnung weist Sie darauf hin, daß ernsthafte Körperverletzungsgefahr besteht.

Avisos Especiales

Los siguientes avisos hacen hincapié en determinada información de la guía. Cada uno de ellos tiene un propósito especial y aparecen con el formato siguiente:

IMPORTANTE: Importante se utiliza para enfatizar cualquier información de procedimiento importante.



Precaucion

La precaución le ofrece información, que de no cumplirse, puede derivar en posibles daños tanto para el software y el hardware, como para ambos.



¡Advertencia!

Una advertencia es un aviso importante, que le advierte sobre la presencia de un inminente peligro.

Telenetics Customer Information

Introduction

U.S.A. customers who have questions about Telenetics products or services should refer to the following sections. Non-U.S.A. customers should contact their local Telenetics subsidiary office or distributor.

Questions about Your Product Shipment

If you have questions about whether your shipment is complete or about its condition upon receipt, please call your nearest Telenetics representative.

Technical Assistance or Scheduling Service

To have Telenetics implement your equipment:

You can purchase and schedule Implementation Services by calling (949) 455-4000 (from within the U.S.). The average lead time for implementation services is 5 business days from the time of the call. Implementation services include running power-up diagnostics, configuring the equipment, and connecting the equipment into existing networks. A service engineer will be dispatched to your site to perform these services.

If you implement your equipment yourself:

Carefully follow the instructions in the following sections of this documentation set:

To install and power up — Chapter 2.



To configure and operate — Chapter 3.

If you have difficulty — Chapter 6 provides a quick reference to problems you may encounter, and suggestions for correcting them.

Telenetics Customer Information *(continued)*

For service, if your unit is under warranty and/or you have a service contract:

Call (949) 455-4000. When you call, please have the following information ready:

<i>Item</i>	<i>Location or Description</i>
Model number	Front of unit. 3260, 3261, 3262, 3263, 3265, 3266, 3267, 3268. (For synchronous data compression models, specify SDC.)
Serial number	Bottom of standalone unit; edge of card unit.
Error message/ Problem Description	LCD Display.
Software revision	LCD Display: from [Modulation Mode] 9600 T/D? press  to display the operating status. (Example: DTE 19.2 RELIABL.) Press  until Display Modem ID displays. Press  . SWPart=x displays. The rightmost two digits show the revision level.
Option Settings	Up-to-date configuration worksheet (see the <i>326X Series Modem Reference Guide</i>).
Site ID	Assigned to the customer site by Telenetics at first service call. Customer should store the ID, once assigned.
Application type	Leased line with or without dial restoral or dial. Also specify the data transfer protocol: asynchronous, direct-synchronous, or synchronous data compression (SDC) mode.
Connected hardware	DTE type(s): asynchronous or synchronous terminal or PC.

If you do not have a service contract, and your unit is no longer under warranty:

You can purchase a service contract or arrange for Time and Material services by calling (949) 455-4000.

Sales-Related Issues

Call your local Telenetics sales office or authorized distributor. For a listing of our Sales Offices, visit our Web site at: <http://www.telenetics.com>.

Comments about the Manual

To help us improve our product documentation, please complete and return by mail, or fax to (949) 455-4010, the prepaid comment card on the next page. If you prefer, simply include your name, company, and telephone number and a member of the documentation group will contact you to discuss any comments you might have.

Chapter 1

About the Modem

Contents

Introduction	1-2
Safety and Operational Notices	1-3
Operating the Modem from the Front Panel	1-4
Selecting Programmed Option Sets	1-5
Automatic Calling Interfaces (ACUs)	1-5
AT ACU	1-5
V.25bis ACU	1-5
LPDA2 ACU	1-5
Managing a Modem	1-6
Restoring Data Transmission	1-6
ITU-T V.34 Compliant Modulation Mode	1-6
Synchronous Data Compression (SDC) Feature	1-7
Automode/Multimode Feature	1-7
Remote Configuration	1-8
Error Correction and Data Compression	1-8
Security	1-8
Status Snapshots	1-8
Adaptive Rate System	1-9
Troubleshooting (V.54 and V.22bis Tests)	1-9
Country-Specific Information	1-9
NET Compliance	1-9
CE Regulatory Marking Directive (93/68/EEC)	1-9

Introduction

This chapter summarizes the features and options of the 326X Series Modem. The series includes:

- The 326X V.32bis Series Modem, which operates in V.32bis modulation mode
- The 326X*FAST* Series Modem, which can operate in V.34 modulation mode
- The 326X*FAST*-SDC Series Modem, which can operate in V.34 modulation mode and the Synchronous Data Compression mode

In this guide, references to the modem apply to all of the above, unless stated otherwise.

IMPORTANT: *When you select a modulation mode, you must ensure that the Max Rate (AT*MX) and Min Rate (AT*MN) parameter options are within the valid range for the mode.*

The modem provides reliable data communication over 2-wire **dial lines** and 2-wire or 4-wire **leased lines**, depending on the model. Dial lines are public lines to which all telephone users have access; leased lines, also called private lines, provide a dedicated connection, over lines provided by the telephone company.

Whether you use dial or leased lines, you can operate the modem as follows:

- Using the **front panel**: control keys and liquid-crystal display (LCD)
- Using industry-standard (AT and AT&), and Telenetics-enhanced (AT*) **AT commands** from an attached terminal, *or* commands from an asynchronous communications software package running on an attached PC
- From a **network management system** (NMS)
- Using **call establishment methods**, such as V.25bis or LPDA2 automatic call units (ACUs)

Figure 1-1 shows **desktop**, or **standalone**, modems. The device is also available in high-density **nest cards**, which offer the same features, and can be installed in Telenetics's Modular Nest 9-slot and Modular Nest 21-slot rack-mounted enclosures.

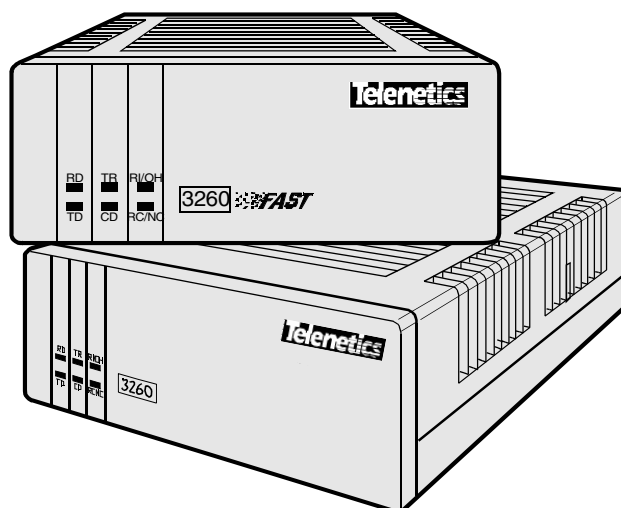

Figure 1-1. 326X Series Modem, Standalone Desktop Model

Safety and Operational Notices

Repair



Warning

Do not attempt to repair the modem or enclosure. They contain *no* electronic components that can be serviced or replaced by a user. Any attempt at user service of the 326X enclosure, or opening of the 326X unit, voids the product warranty.



Avertissement

N'essayez pas de réparer le modem ou le boîtier. Ils ne contiennent aucun composant électronique pouvant être réparé ou remplacé par un usager. Toute tentative de réparation du boîtier du 326X par un usager, ou toute intervention à l'intérieur du 326X, annule la garantie du produit.



Warnung

Versuchen Sie nicht, das Modem oder sein Gehäuse zu reparieren. Es sind keine durch den Benutzer wartungs- oder austauschfähige Teile darin enthalten. Bei jeglichem Öffnen oder Wartungsversuch am 326X bzw.

Lightning



Warning

All Telenetics devices should be used in environments designed for computers and electronic equipment. In areas susceptible to lightning, take precautions to prevent damage to electronic equipment. Contact your telephone company, or an electronic accessories vendor, for information on lightning protection equipment. Customers experiencing problems caused by surges from lightning have eliminated such problems by installing appropriate surge suppressors on power and data lines connected to Telenetics devices.



Avertissement

Tous les dispositifs Telenetics doivent être utilisés dans des environnements conçus pour des ordinateurs et du matériel électronique. Dans les zones susceptibles d'être frappées par la foudre, prenez des précautions pour éviter que le matériel électronique soit endommagé. Contactez votre compagnie téléphonique, ou un vendeur d'accessoires électroniques, pour obtenir des renseignements concernant les systèmes de protection contre la foudre. Certains usagers confrontés à des problèmes causés par des sautes de tension dues à la foudre ont éliminé ces problèmes en installant des régulateurs de tension appropriés sur les câbles électriques et les câbles de données reliés aux dispositifs Telenetics.



Warnung

Telenetics-Geräte sind grundsätzlich in für Rechner und elektronische Anlagen vorgesehenen Umgebungen zu verwenden. In unwettergefährdeten Bereichen ist jegliche Elektronik gegen Blitzeinwirkung zu schützen. Näheres über entsprechende Schutzrichtungen erfahren Sie von Ihrer Telefongesellschaft oder einem Elektrohändler. Probleme mit Spannungstößen durch Blitzeinwirkung lassen sich durch Einbau von Überspannungsableitern in die zu Telenetics-Geräten führenden Netz- und Datenleitungen beheben.

Operating the Modem from the Front Panel

The front panel **menus** are organized functionally so that operation is easy for novice and advanced users.

Refer to Chapter 3, Getting Started, to learn about front panel operation.

Selecting Programmed Option Sets

Option sets make it easy to use a modem with common applications, including:

- Asynchronous and synchronous answering
- Asynchronous and synchronous dialing
- Leased line with dial restoral operation

Four sets of options are stored in nonvolatile memory. If none is appropriate to an application, you can customize an option set, and save it in nonvolatile memory.

Refer to Chapter 4, *Configuring the Modem*, for more information on option sets.

Automatic Calling Interfaces (ACUs)

The modem supports three **automatic calling interfaces** (also known as Auto-Call Units). ACUs let you execute functions directly from a keyboard.

AT ACU

The asynchronous **AT ACU** is compatible with the industry-standard AT command set. AT Commands provide a standard modem communications interface, allowing you to configure and operate your modem from a terminal or PC keyboard.

Using the AT-compatible command set (AT and AT&), you can, for example, dial and receive phone calls. Telenetics' extended AT command set (AT*) includes other important parameters used in configuring advanced modem features.

Refer to Chapter 3, *Getting Started*, and Chapter 5, *Using the AT Automatic Calling Interface*, to learn more about the AT ACU and AT command syntax.

V.25bis ACU

For sync or async **auto-calling**, use the ITU-T V.25bis compliant ACU.

With either the AT or V.25bis ACU, you can store, dial, or change up to nine phone numbers in the modem's electronic telephone book, directly from your terminal.

Refer to Chapter 3, *Automatic Calling Interfaces*, in the *326X Series Modem Reference Guide*, for details.

LPDA2 ACU

The **LPDA2** feature lets you use IBM dial and leased line restoral applications with LPDA2 Dial and Disconnect commands. LPDA2 allows Netview and other IBM applications, like POS outbound dialing applications, to control dialing.

In dial applications, LPDA2 eliminates the need for additional ports and equipment that had been required to support external 801 auto-dialing equipment in IBM environments.

In leased line operation, while connected on the dial line, the modem can monitor for LPDA2 commands in the data stream. If the local modem detects an LPDA2 command, the frame that is being processed is aborted. This prevents the remote DTE from processing the command frame as valid data.

Refer to Chapter 3, Automatic Calling Interfaces, in the *326X Series Modem Reference Guide*, for details.

Managing a Modem

Integral Network Management by Telenetics' 9110, 9000-UX, and 9000-PC Network Management Systems (NMS) is standard. The NMS can configure, monitor, and control local and remote modem operation.

An NMS continuously polls modems to collect management information and check status. Network management traffic, including alarms, commands, events, and polling, is transported to remote modems on an in-band channel that does not disrupt user data traffic nor consume user bandwidth. The modem supports a daisy-chain network management interface, reducing the hardware required for connections.

Refer to Chapter 2, Installing the Modem, for instructions on installing and cabling a modem for use with Telenetics' Network Management Systems.

Restoring Data Transmission

For critical leased line applications that require backup, you can use Models 3261, 3263, 3266, or 3268 in a point-to-point configuration. If the leased line fails, these modems can automatically reroute data traffic through the public switched telephone network (PSTN) over a 2-wire dial line. This integral dial line restoral feature guarantees that data will keep flowing, minimizing network downtime.

ITU-T V.34 Compliant Modulation Mode

326XFAST and 326XFAST-SDC modems support the ITU-T **V.34 compliant modulation mode**. 326XFAST- SDC modems offer the same broad set of features available in the 326XFAST modems, *and* let you take advantage of faster transmission speeds while providing highly reliable data transmission in full-duplex synchronous environments.

326XFAST modems have a line probing feature that optimizes performance on every connection by automatically choosing the optimum bandwidth, carrier frequency, and data rate.

V.34 Modulation Mode Characteristics

V.34 modulation mode characteristics are as follows.

Data Rate: 2.4, 4.8, 7.2, 9.6, 12.0, 14.4, 16.8, 19.2, 21.6, 24.0, 26.4, 28.8, 31.2, and 33.6 kbps

Baud Rate: 2400, 2743, 3000, 3200, and 3429. Some baud rates do not support all data rates.

Carrier Frequency: 1600, 1646, 1800, 1829, 1920, 1959, and 2000 Hz. Some baud rates do not support all carrier frequencies.

Modulation: V.34 is a four-dimensional trellis-coded modulation standard that uses precoding and pre-emphasis equalization schemes.

Compatibility in V.34 Modulation Mode

326XFAST Series Modems (operating in V.34 Auto modulation mode), are compatible with modems that do not support the V.34 modulation mode, by automatically negotiating the highest common modulation mode (e.g., V.32bis).

V.90 Compatibility: Release 8.1 software enables 326X modems to operate with V.90 modems in dial-up connections. With this software, 326X modems can communicate with V.90 modems and negotiate V.34 rates. The release does not provide 56kbps rates for 326X modems, nor 326X rates higher than the V.34 33.6 kbps standard. An upgrade to 8.1 is not required for modems used only in leased-line applications.

Synchronous Data Compression (SDC) Feature

The 326XFAST Series Modem is available in a **synchronous data compression (SDC)** model. 326XFAST products offer all the features of the 326XFAST family, plus *synchronous* DTE rates at 72.0 kbps or higher.

The 326XFAST-SDC Modem is an ideal alternative to costly digital services. Whether your application requires dedicated bandwidth, bandwidth on demand, synchronous dial-up, or dial backup, the 326X-SDC provides optimum throughput for all HDLC/SDLC-like environments, such as X.25, Systems Networking Architecture (SNA), Statistical Multiplexer, and Router networks.

Refer to Chapter 4, Configuring the Modem, for details.

The synchronous data compression feature in the 326XFAST-SDC Modem is Teletics' proprietary technology.

Automode/Multimode Feature

Using **Automode/Multimode**, the modem can automatically negotiate the highest common modulation speed (within a modulation mode) with another modem.

Remote Configuration

Using the local front panel, an NMS, or local-modem AT ACU, you can **configure a remote** modem. You can also read the remote modem's status snapshots and receive its configuration summary on a front panel or async terminal.

Error Correction and Data Compression

The modem provides **error correction and data compression** in accordance with the V.42 and V.42bis ITU-TS recommendation. With V.42, modems automatically determine whether to use Microcom Networking Protocol (MNP) Level 4 or Link Access Procedure for Modems (LAPM) for error correction. Depending on the scheme negotiated, the modem uses MNP Level 5 or V.42bis data compression. The SDC modem uses LAPM with Telenetics' proprietary data compression technology.

Security

The modem provides access **security** at two levels:

- Front panel
- Modem access

Front panel security lets you password-protect a modem from access by other users. This prevents unauthorized changes from being made to a configuration. Front panel security does not prevent you from using the modem.

You can also screen incoming calls so that unauthorized users cannot access a modem. This is accomplished with password and callback functions.

Appendix A explains how to configure security features.

Status Snapshots

The modem's **status snapshot** feature lets you view a local or remotely controlled modem's EIA signals and Telenetics circuit quality monitoring system (CQMS) parameters, and view a configuration summary.

CQMS parameters continuously estimate major line parameters without disrupting data traffic. Measurement of such selections as signal-to-noise ratio and receive level helps you to isolate causes of degraded network performance.

Adaptive Rate System

With the Adaptive Rate System enabled, the 326X Series Modem continuously **optimizes its transmit speed** within the V.34, V.32bis, V.32 (coded and uncoded), and V.22bis modulation modes. By constantly monitoring signal quality, the modem adapts to the optimum transmission rate allowed by line conditions, ensuring maximum throughput and efficiency.

Troubleshooting (V.54 and V.22bis Tests)

The modem supports a full range of ITU-TS V.54 and V.22bis compatible tests to help isolate and correct problems.

Refer to Chapter 6 for typical problems and ways to correct them. Chapter 6 also lists the supported diagnostic tests, and instructions for initiating and terminating tests using either the front panel control keys or AT commands.

For details on tests, refer to Chapter 4 of the *326X Series Modem Reference Guide*.

Country-Specific Information

Telephone company regulations vary by country. Because of this, there are minor physical or operational differences among 326X Series Modem models.

Appendix C, Country-Specific Information, provides cabling, rear panel layouts, interface pinouts, and other modem features that are required or restricted by country regulatory agencies.

NET Compliance

This release of the 326X Series Modem complies with the European Telecommunication Standards Institute's (ETSI) Net 20, 21, 22, 23, and 25.

CE Regulatory Marking Directive (93/68/EEC)

This product is **CE** marked to indicate compliance with the following European directives:

- 73/23/EEC Low Voltage Directive (Safety)
- 89/336/EEC EMC Directive

Compliance with the above directives may only be assured when the equipment is installed and operated in accordance with the instructions for its use and the purpose for which it is intended.

Products that do not bear the **CE** mark are not intended for supply or use in the European Union.

Chapter 2

Installing the Modem

Contents

Introduction	2-2
Unpacking the Modem	2-3
Additional Equipment Required	2-4
Choosing a Site	2-4
Connecting the Modem	2-5
Rear Panel Connectors	2-5
Ferrite Cylinders	2-7
Cabling the Modem	2-11
Connecting the Modem to a Network Management System	2-13
Turning on the Modem	2-14
Automatic Self-Test	2-15
After Installing the Modem... ..	2-15

Introduction

This chapter describes how to install and connect a 326X Series Modem. In this chapter, you:

- Unpack the modem
- Choose an appropriate site to install the modem
- Familiarize yourself with the modem's rear panel and connectors
- Connect the modem to a PC or other data terminal equipment (DTE)
- Connect the modem to a telephone handset (if appropriate) and to the dial/leased telephone line jacks
- Attach ferrite cylinders, if necessary
- Connect the modem to a Network Management System (NMS), if appropriate
- Turn on the modem and run the unit's automatic self-test

IMPORTANT: *Telephone company and governmental regulations vary by country. Your modem's rear panel layout and cabling may vary from that shown in this guide.*

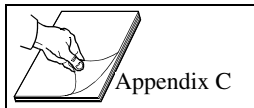

Refer to Appendix C for a description of the modem rear panel and cabling; important safety guidelines for connecting the modem in your country; and regulatory restrictions and requirements.

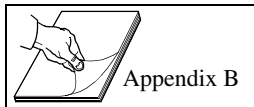

To order cables, refer to Appendix B; then contact your Telenetics sales representative or local distributor for ordering information.

NOTE: If you are installing a 326X Series Modem card, refer to the addendum, *326X Series Modem Cards*, shipped with your modem's backplane.

Unpacking the Modem

The modem is wrapped in reusable shock-absorbent packing material. Save the carton and packing material for later reuse. Telenetics supplies the items shown in Figure 2-1 with the modem.

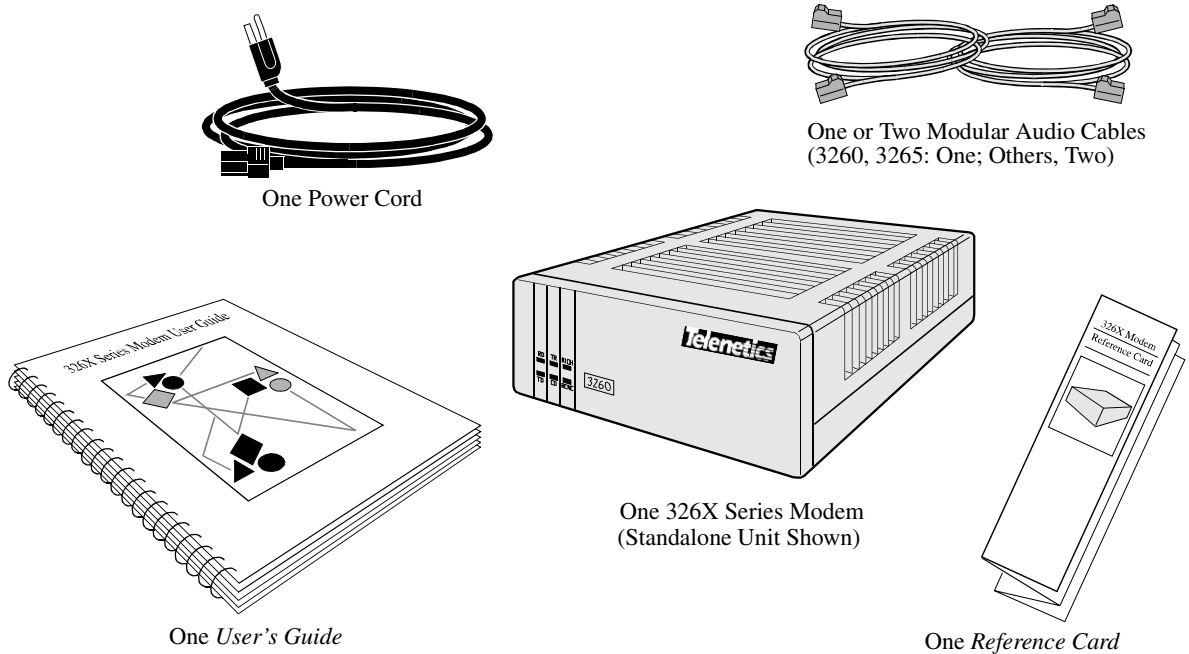

Figure 2-1. Unpacking the Modem

If the equipment is damaged, contact the shipper. If you have further concerns about damage or missing parts, contact your nearest Telenetics representative, or:

In the U.S.A.:

Telenetics Customer Support
25111 Arctic Ocean
Lake Forest, CA 92630
(949) 455-4000

Outside the U.S.A.:

The nearest Telenetics distributor can be found by accessing our Web site at:
<http://www.telenetics.com>

Additional Equipment Required

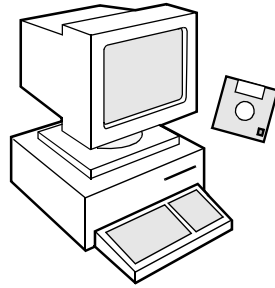

Personal Computer with Communications
Software Package

Modem-to-Terminal Cable

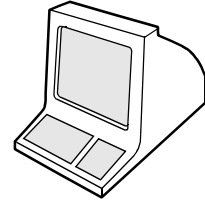
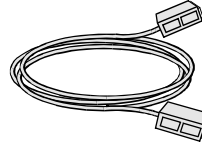

Asynchronous or Synchronous
Terminal (DTE)

In addition to the items supplied with the modem, you may need the following:

- *Communications Software Package*

Many modem applications are controlled by communications software that supports serial communications. When connecting a modem to a terminal, communications software is unnecessary. (Refer to Chapter 3 and Chapter 4 for more information.)

- *Serial Cable*

A shielded, straight-through modem-to-terminal cable, data communications equipment (DCE) to data terminal equipment (DTE) cable, is required. The cable must have a 25-pin D male connector and a DTE connector.

For modem-to-modem (or other DCE-DCE connection), use a crossover cable.

The cable must support the modem signaling your application requires. Select a cable based on your computer and the DTE pin assignments in Appendix B.



Choosing a Site

Where you place the modem can affect its operation. To enhance performance:

- Install the modem in a clean, well-lighted area that is free from temperature extremes and dust.
- Do not place anything on top of a modem.
- Locate the modem no more than the EIA-recommended distance from a DTE and within 6 feet (1.83m) of a grounded AC power outlet.
- Do not place anything within 1 inch (2.54 cm) of either side of a modem. Also, to prevent overheating, do not place a modem on its side.

Refer to Appendix C for site requirements for operating the modem in your country.

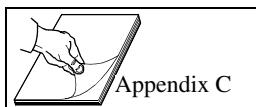

Connecting the Modem

Rear Panel Connectors

Figures 2-2 and 2-3 show 3260/3265 and 3261/3266 standalone modem rear panels. The rear of the modem has the following connectors:

- **Modular jacks** for making:
 - DIAL LINE and PHONE connections (3260/3265 Modems) *or*
 - DIAL LINE, PHONE, and LEASE LINE connections (3261/3266 Modems)
- One **6-position Dual Inline Package (DIP) switch**. This switch “hard-configures” some operating functions. When the modem is shipped from the factory, all switches are in the Off (up) position. DIP switch selections *cannot* be overridden by remote front panel configuration. Refer to Appendix C for DIP switch function details.
- **Network Control (NC) IN and OUT ports** for connecting to Telenetics’ Network Management Systems (NMS)
- A **DTE port** for connecting to a PC or DTE
- An **AC power receptacle** to accept an AC line cord
- An **AC power switch**

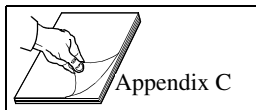

Refer to Appendix C for a description of the modem’s rear panel. For information on 326X Series Modem Card backplanes (models 3262, 3263, 3267, and 3268), refer to the addendum, *326X Series Modem Cards*, shipped with your backplane.

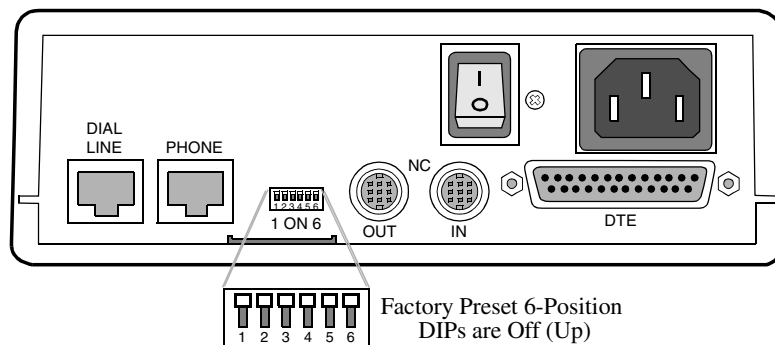

Figure 2-2. 3260/3265 Modem Rear Panel Layout

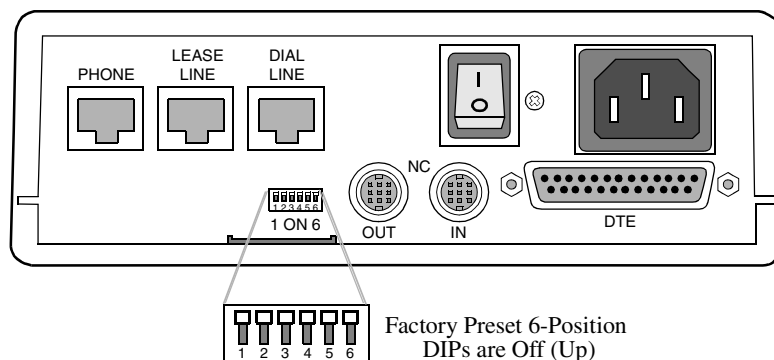

Figure 2-3. 3261/3266 Modem Rear Panel Layout

Electrical Interfaces—EIA/TIA-232 and ITU-TS V.35



Caution

Ensure that the electrical interfaces of the equipment you connect to the modem are compatible. Incompatible interfaces may seriously damage the modem. Telenetics makes no guarantee of the equipment's integrity if you do not ensure that compatible interfaces are used. If your DTE has a different interface, you will need an external converter cable.

326X Series Modems have an EIA/TIA-232/EIA/TIA-562 electrical interface for connection to external equipment. For compatibility with DTEs that have a V.35 interface, the V.34-SDC Modem is also available with the optional ITU-TS V.35 Recommendation electrical interface.

The rear-panel DTE port is configured at the factory for either interface. *Both interfaces are not available in a unit.* Regardless of the interface, external DTEs are connected through the modem's rear-panel DTE port.

NOTE: When operating with the V.35 interface, DIP switch S1 must be set to the off (up) position (see Figure 2-2 or 2-3).

To purchase a compatible cable, consult Appendix B.

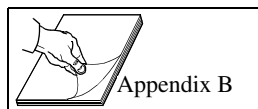

Operating at V.34 DTE Rates

To operate V.34 or V.34-SDC modems at DTE rates greater than 19.2 kbps, you must use cables that can handle the higher data rates. Refer to Appendix B for instructions on determining the correct cables to use.

Ferrite Cylinders

Ferrite cylinders or beads installed on cables filter out line disturbances. They are required on some 326X models in some countries, as described in this section.

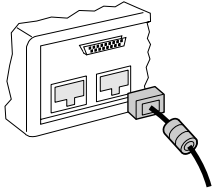

Caution

Install cables with the ferrite end adjacent to the modem.
The ferrite cylinder ensures that the unit operates in compliance with FCC RFI requirements.

Models 3261 and 3266 – Dial Line Connections

Two telephone cables with ferrite cylinders are included in the Model 3261 (U.S.A.) and the 3266 (Canada, Germany, U.K., and Japan) accessory kit. Connect the cables from the modem to 6- or 8-conductor dial-line connections.

Install the telephone cable. Figure 2-4 shows the proper orientation. Figure 2-8, in the next section, shows how to connect the 3261/3266 modem.

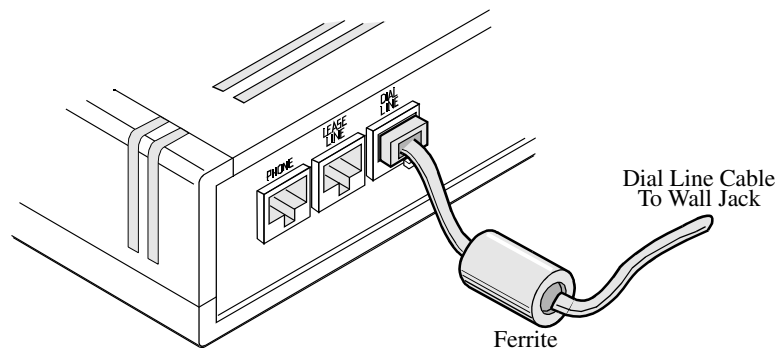

Figure 2-4. Attaching Ferrite Cable to the Modem

Models 3267 and 3268

Ferrite cylinders are required on:

- **Both dial line cables and on DTE cables on the 3267 V.34 Modem**
- **Both audio (leased or dial) cables and on DTE cables on the 3268 V.34 Modem**
- **Power cables on Modular Nest enclosures populated with 3267 and 3268 V.34 Modems**
- **Network management cables on Modular Nest enclosures populated with 3267 and 3268 V.34 Modems**

A cylinder is included with each cable that requires one. Follow the instructions below to ensure correct cylinder installation.

Installing a Ferrite Cylinder on an Audio or Network Management Cable

Do the following for **each cable**:

- 1) Snugly wrap the cable **twice completely around** the cylinder (Figure 2-5).
- 2) Set the cable into the cylinder cutouts.
- 3) Ensure that 1 to 1-1/2 inches of the cable protrude from the cylinder (on the end you insert into the backplane connector).
- 4) Snap the cylinder closed. You can reopen and close it to reset the cable.
- 5) Insert the cable into the modem backplane connector (with the ferrite cylinder close to the backplane connector).

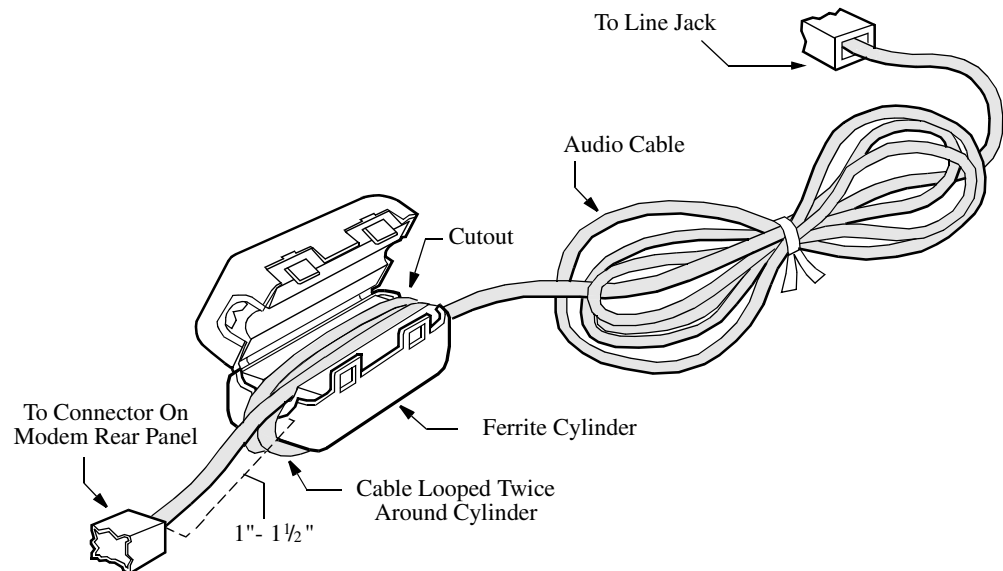

Figure 2-5. Installing a Ferrite Cylinder on an Audio Cable

Installing a Ferrite Cylinder on a DTE Cable

Do the following for **each DTE cable**:

- 1) Pass the DTE cable through the cylinder.
- 2) Set the cable into the cylinder cutouts.
- 3) Position the cylinder as close as possible to the plug you install on the backplane connector.
- 4) Snap the cylinder closed. You can reopen and close it to reset the cable.
- 5) Insert the cable into the DTE connector on the modem backplane connector, with the ferrite cylinder close to the backplane connector.

Installing a Ferrite Cylinder on a Power Cable

Do the following for each power cable of a Modular Nest enclosure populated with **3267 and 3268V.34 Modems**.

- 1) Snugly wrap the cable **once completely around** the cylinder (Figure 2-6).
- 2) Set the cable into the cylinder cutouts.
- 3) Ensure that 1 to 1-1/2 inches of the cable protrude from the cylinder (on the end you insert into the backplane connector).
- 4) Snap the cylinder closed. You can reopen and close it to reset the cable.
- 5) Insert the cable into the Modular Nest enclosure connector (with the ferrite cylinder close to the connector).

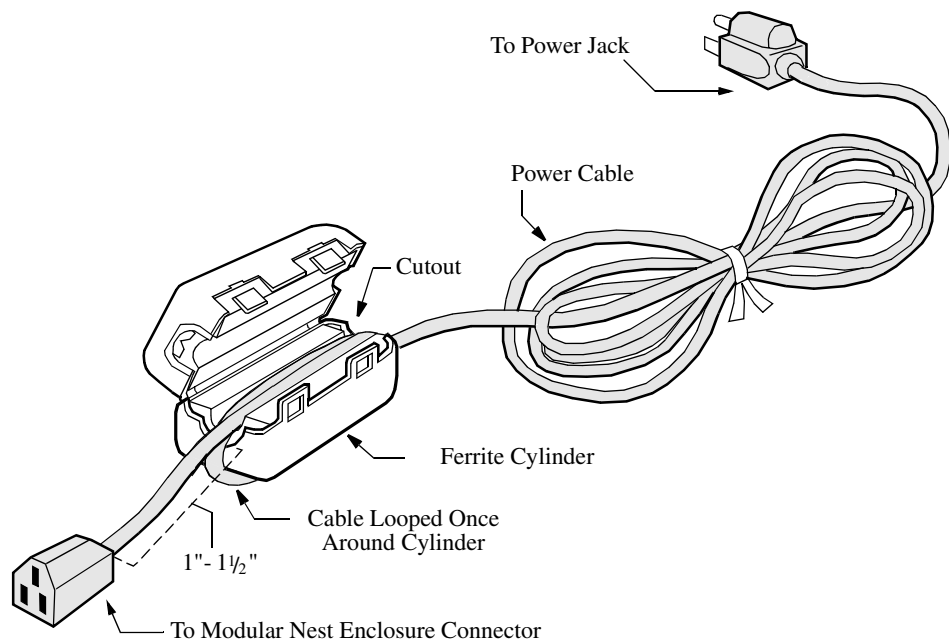

Figure 2-6. Installing a Ferrite Cylinder on a Power Cable

Important Information About the Modular Nest Enclosure Front Door



Warning

For safety, the enclosure front door should remain closed and locked at all times unless you are installing, removing, or configuring product cards.



Avertissement

Pour des raisons de sécurité, la porte d'entrée doit être toujours fermée et verrouillée, sauf lorsque vous installez, retirez ou configurez des cartes.



Warnung

Aus Sicherheitsgründen darf die Klappe auf der Vorderseite nur zum Installieren, Entfernen oder Konfigurieren von Produktkarten entriegelt und geöffnet werden.

Por razones de seguridad, la puerta frontal deberá permanecer cerrada en todo momento, a menos que se proceda a la instalación, extracción o configuración de las tarjetas del producto.

Important Information About the Modular Nest Enclosure

This notice applies to cooling airflow around the Modular Nest unit.



Caution

Failure to properly arrange cables could impede cooling airflow, possibly resulting in damage to the equipment



Mise en Garde

Un mauvais agencement des câbles risque d'empêcher une bonne ventilation et par conséquent de causer des dommages matériels.



Vorsicht

Die inkorrekte Anordnung von Kabeln kann den Kühlluftstrom behindern und zu Geräteschäden führen.



¡Precaucion!

La disposición defectuosa de los cables puede impedir el flujo de aire frío, resultando en posibles daños para el equipo.

Cabling the Modem

This section explains how to connect the modem to:

- 1) A PC or DTE (asynchronous or synchronous terminal)
- 2) A dial telephone line
- 3) A telephone cable (between handset and modem)
- 4) A leased telephone line (if appropriate)
- 5) The power cord
- 6) Network management system cables (if appropriate)

For models 3260/3265, connect modem cables in the order shown in Figure 2-7.

For models 3261/3266, connect modem cables in the order shown in Figure 2-8.



Warning

The modem must be grounded through its electrical plug. If you cannot use the safety plug with your electrical outlet, consult a licensed electrician to ensure that the modem is properly grounded. Unplug the modem from the power outlet before having it serviced.



Avertissement

Le modem doit être mis à la terre lors de son branchement. Si vous n'avez pas de cartouche fusible, consultez un électricien pour assurer la mise à terre adéquate de votre appareil. Mettez-le hors tension avant de commencer toute réparation.



Warnung

Das Modem wird normalerweise über den Stecker geerdet. Wenn Sie den Schuko-Stecker nicht an die Steckdose anschließen können, wenden Sie sich an einen zugelassenen Elektriker, um sicherzustellen, daß das Gerät korrekt geerdet ist. Trennen Sie das Gerät vor dem Öffnen des Gehäuses vom Netz.

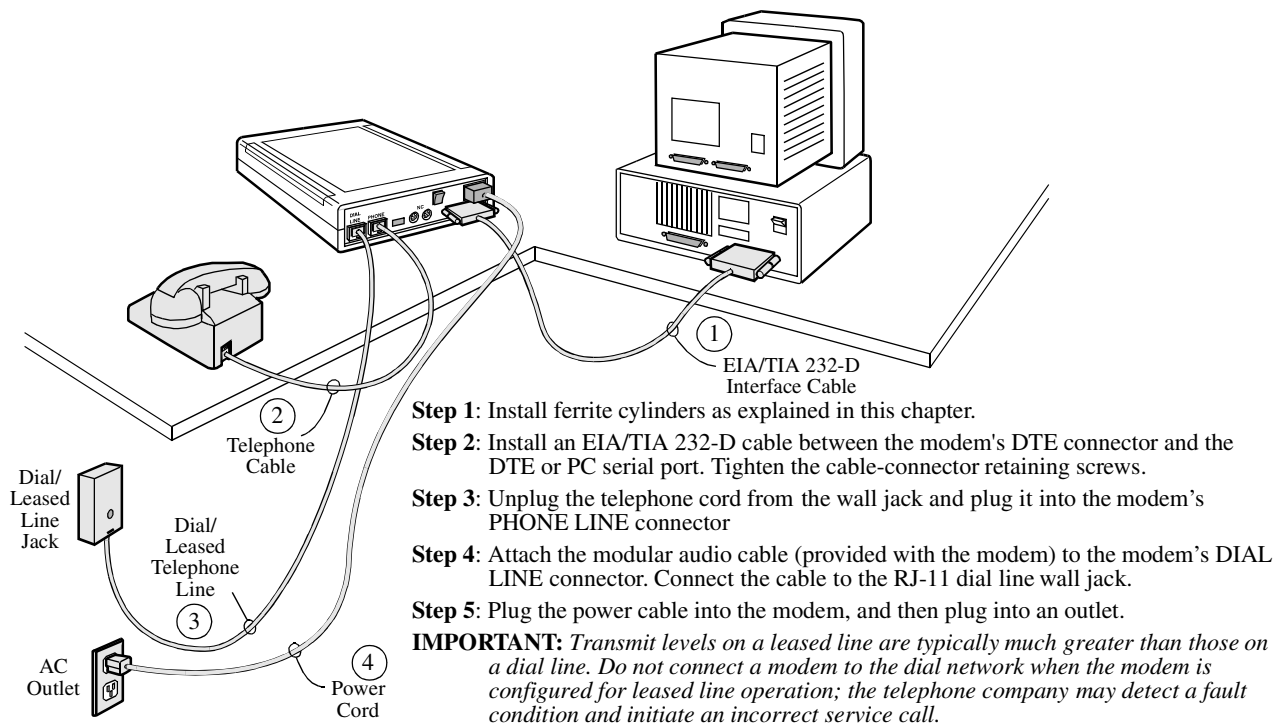

Figure 2-7. 3260/3265 Modem Cabling

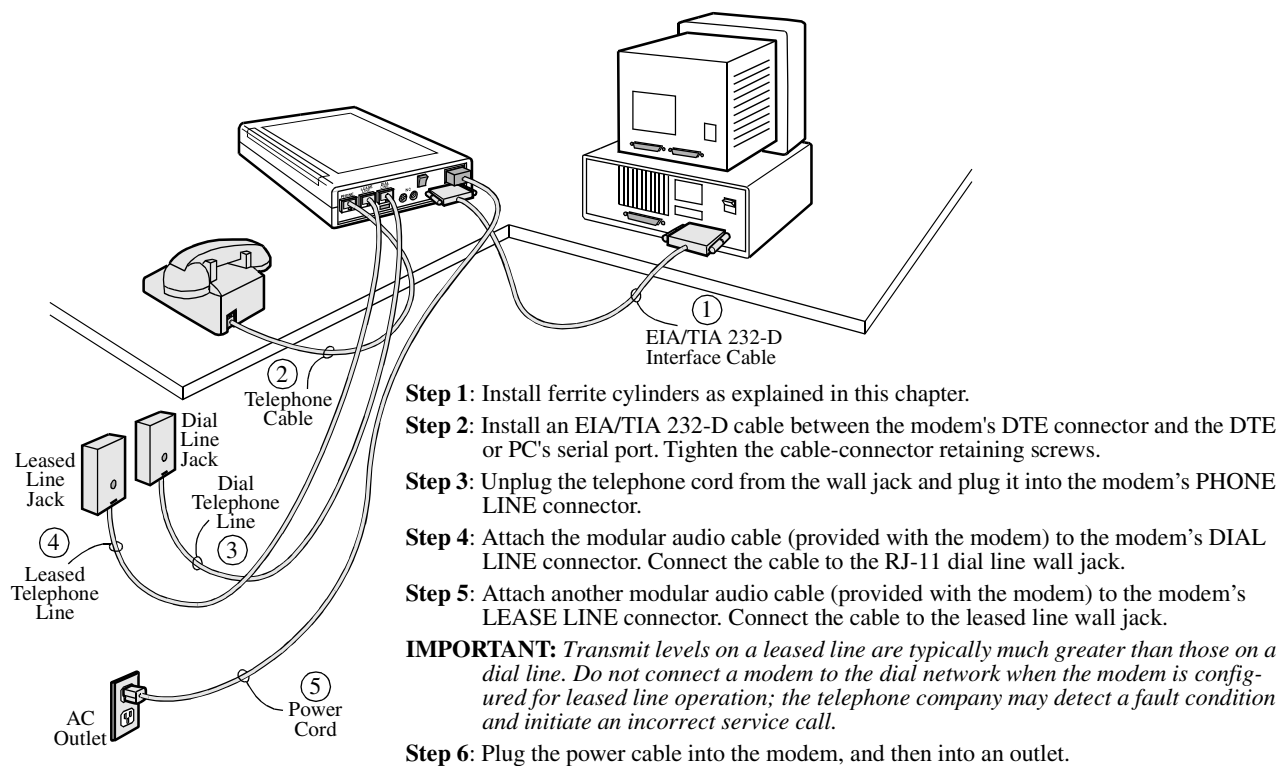

Figure 2-8. 3261/3266 Modem Cabling

Connecting the Modem to a Network Management System

326X Series Modems can be connected to the following Telenetics systems:

- 9110 NMS (Figure 2-9)
- 9000-PC (Figure 2-10)
- 9000-UX (Figure 2-10)

Use the modem's NC IN and NC OUT 8-pin DIN connectors for NMS connections.

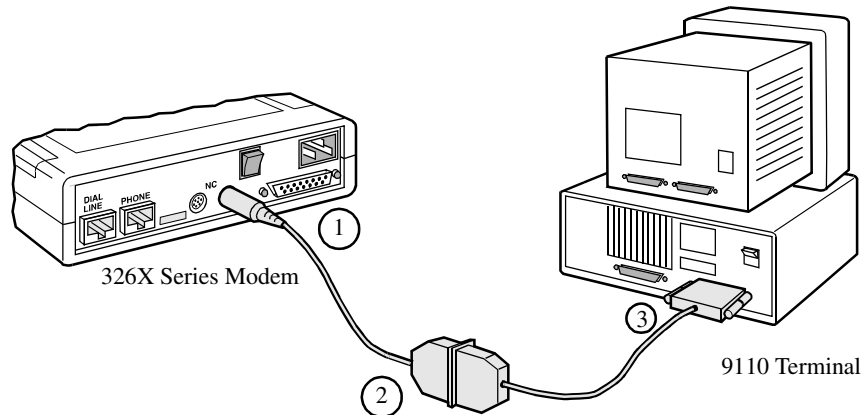

Step 1: Install ferrite cylinders as explained in this chapter.

Step 2: Attach an 8-pin DIN adapter cable connector to the modem's NC IN connector.

NOTE: The modem can be connected to either a 9- or 25-pin serial communication port on the rear of the 9110 DMS. Figure 2-7 shows a 25-pin port connection.

Step 3: Attach the other end of the 8-pin DIN adapter cable to the DB 25-pin connector on the 9110's network control 9- or 25-pin adapter cable.

Step 4: Attach the 25- or 9-pin connector to the appropriate port on the rear of the 9110 DMS.

Figure 2-9. Connecting to a 9110 NMS

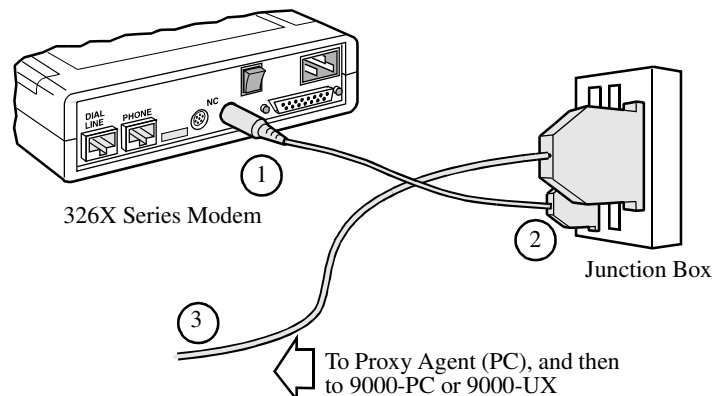

Step 1: Install ferrite cylinders as explained in this chapter.

Step 2: Attach an 8-pin DIN adapter cable connector to the modem's NC IN connector.

Step 3: Connect the 8-pin control-channel connector on the other end of the 8-pin DIN adapter cable into its receptacle on a junction box.

Step 4: Attach the 50-pin connector on the network control cable to the junction box. Connect the other end to the appropriate Digi-Board on the rear of the NMS Proxy Agent PC.

Figure 2-10. Connecting to a 9000-PC or 9000-UX NMS

To connect **multiple modems in a daisy chain configuration**, refer to Figure 2-11.

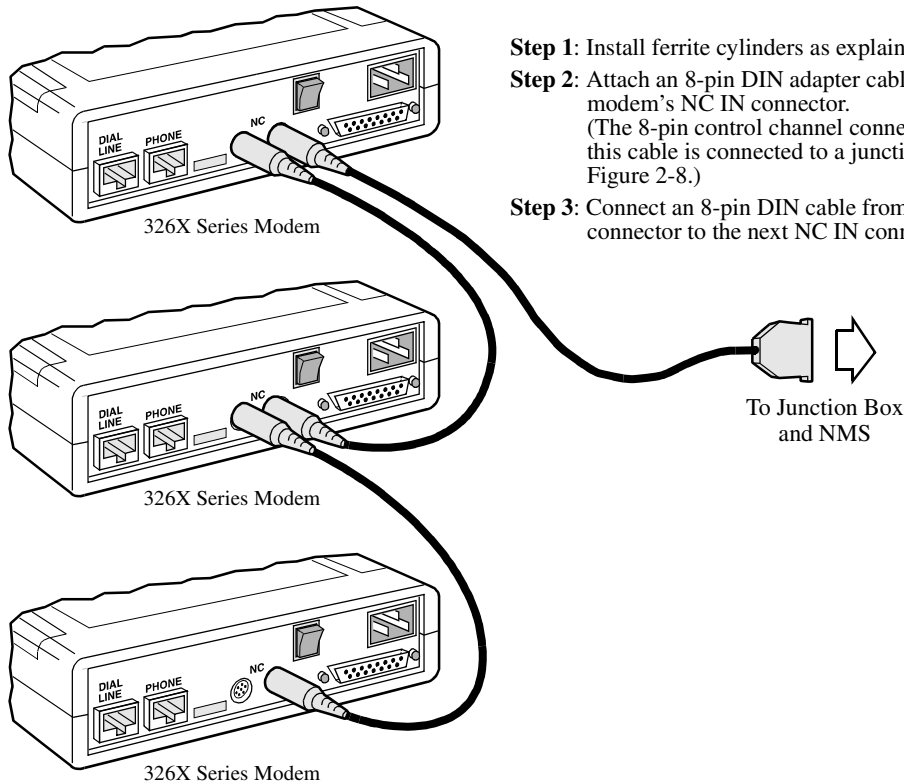

Step 1: Install ferrite cylinders as explained in this chapter.

Step 2: Attach an 8-pin DIN adapter cable connector to the modem's NC IN connector.
(The 8-pin control channel connector at the other end of this cable is connected to a junction box, as shown in Figure 2-8.)

Step 3: Connect an 8-pin DIN cable from the first NC OUT connector to the next NC IN connector, and so on.

Figure 2-11. Connecting Modems in a Daisy Chain Configuration

To attach modem **enclosure cards** to an NMS, refer to the addendum, *326X Series Modem Cards*, shipped with the modem backplane.

Turning on the Modem

The power cable connects the rear of the modem to a standard 115V outlet. After making other connections, plug the power cable into the modem, and then plug it into an outlet. Turn the rear panel power switch to the On (up) position.

When powered on, the modem automatically performs a self-test of internal circuits. The "Automatic Self-Test" section, next, describes this test and the front panel displays that can follow it.

Automatic Self-Test

When you apply power to the modem, it automatically runs a self-test that checks for and identifies faults in the modem's circuits. After displaying the message **SELF-TEST**, the front modem displays one of the messages shown in Table 2-1.

Table 2-1.
Self-Test Messages

<i>This Message...</i>	<i>Indicates:</i>
326X Initial	The modem is set to operate using factory default values.
326X Ready	No faults were encountered during the self-test. The modem is ready for operation.
[Error message]	A system fault was detected during the self-test.

Handling Error Messages

If the modem fails the self-test and displays an error message, do the following:

- 1) Record the message to assist in troubleshooting the modem.
- 2) Turn the modem off and then on again, and observe the front panel display. If the modem displays **326X READY**, the earlier error message was probably caused by a temporary power line problem. Some line problems do not affect modem operation. If the modem continues to display an error message, contact Telenetics Customer Support or an authorized Telenetics distributor.

After Installing the Modem...

Go on to Chapter 3, Getting Started, for information on how to configure and operate the modem.

Chapter 3

Getting Started

Contents

Introduction	3-2
System Requirements for Software Upgrades	3-2
Configuring and Operating the Modem	3-2
Using the Front Panel	3-2
Navigating the Configuration Menu Tree	3-5
Setting Configuration Options from the Front Panel	3-5
Using the Modem with a Network Management System (NMS)	3-7
Using the AT Automatic Calling Unit (ACU)	3-8
Other Call Establishment Methods	3-10
V.25bis ACU for Sync or Async Applications	3-10
NetView LPDA-2 ACU for Sync Applications	3-10
Sync Dialing from an IBM AS 400	3-11
External Auto-Call Units	3-11

Introduction

This chapter has three parts:

- System Requirements for Software Upgrades
- Configuring and Operating the Modem
- Other Call Establishment Methods

System Requirements for Software Upgrades

This section explains the prerequisites for an upgrade to 7.9 software. This section **does not apply to new units with 7.8 or higher** software installed.

A modem can be upgraded to Release 7.9 software only if it has Release 7.0, 7.5, 7.6, or 7.7 software.

Configuring and Operating the Modem

You can configure and operate the modem in several ways:

- From the **modem front panel**
- From a **Network Management System (NMS)**
- From the **modem AT Automatic Calling Unit (ACU)**, if it is attached to an asynchronous “dumb” terminal—a terminal without software—or to a PC running an asynchronous communications software package

Each of these is described in the sections that follow.

If You Are Unsure of Your DTE’s Data Format...

The DTE manual should tell you what data format—asynchronous or synchronous—it uses. Most PC applications use an asynchronous data format.

Using the Front Panel

You can configure and operate all modem functions using the front panel’s:

- Light-emitting diodes (LEDs)
- Liquid crystal display (LCD)
- Configuration menus
- Control keys

Figures 3-1 and 3-2 show the stand-alone modem front panel. Figure 3-3 shows the enclosure card front panel. Note the LCD, LEDs, and control keys.

NOTE: Information specific to enclosure card modems is covered in the addendum, *326X Series Modem Cards*, shipped with the modem backplane.

IMPORTANT: To use the front panel keys, the modem must be connected to an AC power source, the rear panel power switch must be turned on, and rear panel DIP Switches #3 and #6 must be set to the Off (up) position. See Chapter 2 for details.

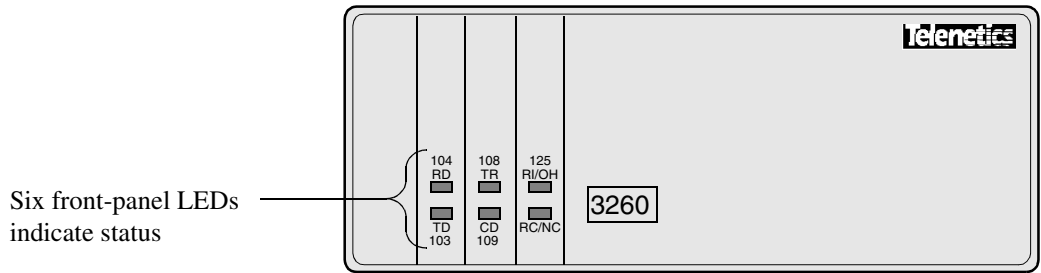

Figure 3-1. Standalone 3260 Modem with Front Cover Closed

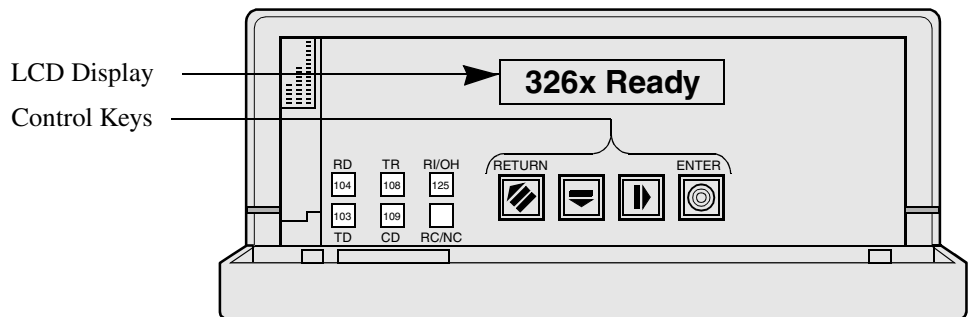

Figure 3-2. Standalone 3260 Modem with Front Cover Open

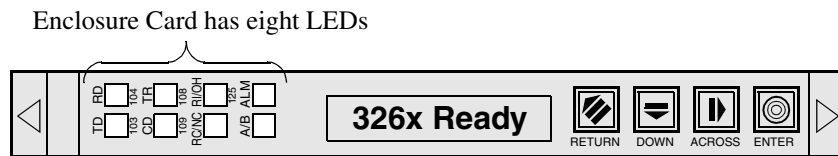



Figure 3-3. 3260 Modem Enclosure Card Front Panel

LEDs show the status of key DTE interface signals. If a communication problem occurs, LEDs can help you determine the cause. (Refer to Chapter 6 for a quick reference to problems and how to correct them.) Table 3-1 describes LED functions.

**Table 3-1.
326X LEDs**

LED	Name	Description
TD	Transmit Data	Flashes when the modem accepts data from the local DTE, to transmit.
RD	Receive Data	Flashes when the modem passes received data to the local DTE.
RI/OH	Ring Indicator/ Off-Hook	On when an incoming call is ringing, and when the modem is off-hook and connected to the dial line.

Table 3-1.
326X LEDs

LED	Name	Description
CD	Data Carrier Detect	On when the local modem receives a carrier signal (as defined by the current modulation mode) from the remote modem or when the DCD parameter=High.
TR	Data Terminal Ready	On when a DTR signal from a terminal is detected.
RC/NC	Remote Control/ Network Control	Flashes to indicate that the modem is under remote configuration (via front panel or AT ACU). On when the modem is under NMS control.
A/B	A or B	Enclosure cards only. On when modem A front panel information is displayed. Off when modem B front panel information is displayed. To toggle between modem A and modem B front panels, hold  and then press  .
ALM	Alarm	Enclosure cards only. On when a test is in progress or a modem failure occurs. With the 3262/3267 Modem card, if one modem fails, the ALM LED lights and remains lit regardless of which modem front panel is being viewed.

Front Panel Display

The front panel has a 16-character alphanumeric LCD display (see Figure 3-2 or 3-3). You access the configuration menu tree through this display, to:

- Configure the modem
- Store and view telephone numbers
- Initiate and answer calls
- View status information
- Run online tests
- Enter passwords and network addresses

Navigating the Configuration Menu Tree

This section describes the modem **menu tree structure**. It explains how to access **parameters** using the front panel control keys.

Menu Structure

The menu structure consists of fifteen **categories**, which appear in capital letters. Example: CONFIGURATION OPT'S.

Each category has **parameters** (example: **Mode**). Some parameters are configurable; others indicate modem and call status. Most parameters have selectable **options**. Options affect the modem's operating characteristics.

You can view parameters and options in the front panel LCD display. If options can be set, the following indicators display:

- An **equals sign (=)** indicates the currently selected option of the parameter
- A **colon (:)** indicates that the displayed option is available but is not selected

Each parameter has a **default option**:





- Some defaults are determined by the assigned factory-preset option sets (preconfigured option sets). These defaults are exclusive to an option set.
- Other factory options are not exclusive to an option set and they always have the same default setting, regardless of which factory-preset option set you use.

Refer to Appendix A, Figure A-1, or to the *Reference Card* to see the complete menu tree structure, including the available and default options.

Setting Configuration Options from the Front Panel

The four **control keys** (Figures 3-2 and 3-3) let you access parameters and options. Table 3-2 describes control key functions.

Table 3-2.
Front Panel Keys

Keys	Function
 <i>Return</i>	Steps up through the menu tree from a parameter to a category, or from a category to the default display. Example: from Test= , pressing  displays the TEST OPTS category. Pressing  again displays the default display, such as, DATA 9600 T/D?
 <i>Across</i>	Steps through the parameters in a menu category.

NOTES:





- 1) If you hold the  or  key down, it repeats until you stop pressing.
- 2) With the 3262/3267 Modems, to toggle between modem A and modem B front panels, hold  while pressing .

Table 3-2.
Front Panel Keys

Keys	Function
▼ <i>Down</i>	Steps through categories (example: Data 9600 T/D?, TEST OPTS, MODULATION OPT'S), <i>or</i> , at a parameter within a category, scrolls through the options.
⊙ <i>Enter</i>	Selects an option and/or initiates an action. This key also serves as a Talk/Data “softkey,” allowing you to toggle between using a telephone and the modem to establish a telephone connection.

NOTES:

- 1) If you hold the ▼ or ► key down, it repeats until you stop pressing.
- 2) With the 3262/3267 Modems, to toggle between modem A and modem B front panels, hold ▩ while pressing ⊙.

Example: Accessing a Configuration Option

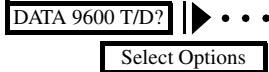

To select a predefined configuration option set:

- 1) From the **Data 9600 T/D?** display, press ► until **Select Options=1** displays.
- 2) Press ▼ to display **Select Options:2**, **Select Options:3**, or **Select Options:4**.
- 3) Press ⊙ to select an option. The modem is now configured for the option.

Status Displays

The **Data 9600 T/D?** category is the default display when the modem is powered-up or after the modem has “timed-out” (i.e., the front panel control keys have not been used for at least five minutes). The data rate (9600, in the display **Data 9600 T/D?**) is the current DCE (modem-to-modem) data rate. It varies with the speed at which the modems connect. The **Data 9600 T/D?** category serves three primary functions:

- Talk/Data” Switch
- Operating Status Displays
- Option Sets/Dialing Options

Talk/Data Switch

Pressing ⊙ when **Data 9600 T/D?** is displayed toggles the modem between using:

- An external telephone to manually dial a telephone call
- The modem to dial a stored or unstored telephone number

Operating Status Displays

The DTE19.2 RELIABL and Phase Jitter subcategories let you view modem operating status. Example: in the DTE 19.2 RELIABL subcategory, pressing ▼ displays:

- Operating status messages
- DTE/DCE rate/status
- Error correction/data compression status
- EIA/TIA signal status
- Disconnect reasons
- The modem's software revision level
- Circuit Quality Monitoring System (CQMS) parameter status

For details, refer to Appendix A. For details on status displays, refer to Chapter 1, AT Commands, of the *326X Series Modem Reference Guide*.

Option Sets/Dialing Options

These status subcategories let you choose a preconfigured option set, and make other selections to determine how the modem will establish telephone connections.

For details on configuring option sets and other call establishment options in this category, refer to Appendix A.



Where Do I Go from Here?

When you are familiar with the front panel, configuration menu system, and control keys, refer to the following:

- **Chapter 4** for specific configuration instructions.
- **Appendix A** to change parameter options, and to enter and dial a telephone number. The *Reference Card* shows the complete menu structure.
- **Chapter 6** for a discussion of typical problems and ways to correct them.

Using the Modem with a Network Management System (NMS)

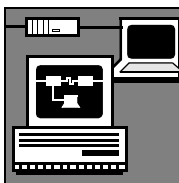

Modem functions can be configured and controlled from an NMS. Refer to:

- The network management system documentation
- Appendix A for brief descriptions of parameter options and features
- The *326X Series Modem Reference Guide* for detailed descriptions of parameter options and features

Using the AT Automatic Calling Unit (ACU)



To connect the modem to an **asynchronous terminal**—a terminal without software—*or* a **PC running an asynchronous communications software package**, you use the modem's AT Automatic Calling Unit (ACU) interface.

The AT ACU is compatible with:

- The *industry-standard* AT command set (AT and AT& commands)
- The Telenetics *enhanced* AT command set (AT* commands)

AT commands define how the modem is configured, how it makes calls, and what test operations it performs. The AT command set lets you configure and operate modem options and features from the PC or asynchronous terminal keyboard.

Using the Modem with an Async Terminal

If you are connecting the modem to an asynchronous terminal, you can use the AT ACU to configure parameter options from the keyboard. Learn the AT command syntax in order to generate the appropriate AT commands.

Where Do I Go from Here?

To continue configuring the modem from an asynchronous terminal, refer to:

- **Chapter 4** for configuration instructions.
- **Chapter 5** to learn AT command syntax.
- **Chapter 6** for a discussion of common problems and how to correct them.
- **Appendix A** to change configuration options. The *Reference Card* shows the complete menu structure.

(The modem also supports an ITU-TS V.25bis ACU for initiating calls from an asynchronous or synchronous DTE, described later in this chapter.)



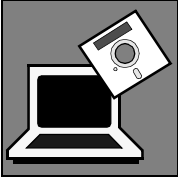

Using the Modem with a PC and Async Communications Software

When using the modem with a PC, you need communications or terminal emulation software. Communications software acts as an interface—with pull-down menus or graphics—between your PC and modem, allowing you to perform modem operations from your PC.

It is unlikely that you will use AT commands directly to configure and test the modem. Some communications software, however, may not support all of the modem's configuration options or may require you to issue commands to the modem directly.

Communications software packages that directly support the modem (where **Telenetics 3260 Modem**, **Codex 3260 Modem**, or **Motorola 3260 Modem** is a selection within the package) support the industry standard commands (AT, AT&) and the Telenetics-enhanced commands (AT*), making more knowledge of AT command syntax unnecessary.

Communications software packages that offer a **Hayes-Compatible** selection do not support Telenetics-enhanced commands: (AT*). In this case, you may enter AT* commands yourself, if required by your application.

Where Do I Go from Here?

*If your communications software package supports a **3260 Modem** (or a comparable 3260 selection), refer to:*

- **Chapter 4**, the “Communications Software Package Operating Notes” section.
- **Chapter 4**, the “Configuration Option Sets” section.
- **Appendix A** to change configuration options. The *Reference Card* shows the complete menu structure.

*If your package does **not** support all of the modem's configuration options, or requires you to issue AT commands to the modem directly, refer to:*

- **Chapter 5** to learn AT command syntax.
- **Chapter 6** to resolve problems that you have isolated to the modem.
- Communications software documentation.

*If your package supports a **Hayes-Compatible** selection, refer to:*

- **Chapter 4**, the “Communications Software Package Operating Notes” section.
- **Chapter 5** to learn AT command syntax.
- For AT* configuration settings, refer to:
 - **Chapter 4**, the “Configuration Option Sets” section.
 - **Appendix A** to change configuration options. The *Reference Card* shows the complete menu structure.
- **Chapter 6** to resolve problems that you have isolated to the modem.



Other Call Establishment Methods



In addition to the configuration and operation methods in this chapter, the modem supports other methods to establish and manage telephone connections:

- **V.25bis ACU** (for synchronous or asynchronous applications)
- **NetView LPDA-2 ACU** (for synchronous applications)
- **IBM AS 400** (for synchronous dialing)
- **External Auto-Call Units** such as the **Bell 801C**

These methods are described in the sections that follow.

V.25bis ACU for Sync or Async Applications

The modem supports an ITU-TS V.25bis ACU for initiating calls from an intelligent terminal, in synchronous or asynchronous formats, which supports:

- Addressed mode, to perform call-related tasks, such as storing phone numbers in memory, dialing calls from memory, connecting/disregarding incoming calls
- Manual and direct call establishment methods. Direct mode lets you use DTR transitions from the DTE to establish calls. Manual mode lets you manually initiate and answer calls with a telephone and then transfer the call to the modem.

Where Do I Go from Here?



For more information on the V.25bis ACU, refer to Chapter 3, Automatic Calling Interfaces, in the *326X Series Modem Reference Guide*. Programmers and System Developers should also refer to Chapter 3 for a programming guide describing asynchronous and synchronous data formats using the ASCII/EBCDIC character sets.

NetView LPDA-2 ACU for Sync Applications

The modem supports Link Problem Determination Aid (LPDA-2). LPDA-2 is the communications protocol between IBM host software and transmission devices for exchanging diagnostic and control information. LPDA-2 commands provide a means for an attached terminal to command the modem to dial a telephone number and report back if the call is successful or not successful.

Where Do I Go from Here?



For more information on using the LPDA-2 ACU, refer to Chapter 3, Automatic Calling Interfaces, in the *326X Series Modem Reference Guide* for configuration information and for information on NetView's LPDA-2 dialing commands.

Sync Dialing from an IBM AS 400

The modem can be configured to operate as a synchronous originate modem with the **IBM AS 400**. The AS 400 supports switched operation with call origination via a V.25bis-compliant call establishment driver. In this type of application, the modem is driven by the APPC/APPN bit-synchronous protocol.

Where Do I Go from Here?

For more information on using the modem with an IBM AS 400, refer to:

- **Chapter 4** for configuration instructions.
- **Chapter 3, Automatic Calling Interfaces**, in the *326X Series Modem Reference Guide* for details on bit-synchronous protocol frame formats and the V.25bis protocol.



External Auto-Call Units

The modem can be used with applications that support external dialers, such as the **Bell 801C**. Once an external dialer establishes a call, it passes control of the dial line to the modem by the MI/MIC control leads on the DIAL LINE connector. **NOTE:** This type of application is supported in Canada and the U.S.A. only.

Where Do I Go from Here?

For more information on external call units, refer to Chapter 3, Automatic Calling Interfaces, in the *326X Series Modem Reference Guide*.



Chapter 4

Configuring the Modem

Contents

Overview	4-2
Communications Software Package Operating Notes	4-2
Configuring the Modem for Use with Communications Software	4-2
Operating Notes	4-3
If the Communications Software and Modem Do Not Operate... ..	4-5
Preparing for Operation	4-5
Reinitializing Memory from the Front Panel	4-5
Reinitializing Memory Using the AT&F Command	4-5
Configuration Option Sets	4-6
What is an Option Set?	4-6
Configuring an Option Set	4-10
Option Set Defaults	4-11
326X V.32bis and 326X <i>FAST</i> Modem Application Examples	4-16
Option Set 1—Async Calls to Central Site Using AT ACU	4-17
Option Set 2—Sync Answering Central Site Without ACU	4-18
Option Set 3—Sync Calls to Central Site, V.25bis ACU	4-18
Option Set 4—Async Answering Central Site without ACU (Models 3260/62/65/67)	4-19
Option Set 4—Synchronous Leased Line Applications with Dial Restoral (Models 3261/63/66/68)	4-20
326X <i>FAST</i> -SDC Modem Application Examples	4-21
SDC Pre-Operation Notes	4-21
Configuring the Modem for SDC Operation	4-22
SDC Sample Applications	4-22
Remote Access Reset	4-28
Operation	4-28
When Remote Access Reset Is Disabled	4-28

Overview

This chapter explains how to configure the modem, in conjunction with Chapter 3, Getting Started. *Read Chapter 3 before continuing.* Then select an option:

- **If the application requires a communications software package**, read the section, “Communications Software Package Operating Notes”.
- **If you have previously installed the 326X in another application**, the section “Preparing for Operation” explains how to reinitialize the modem memory so it can be installed in a new application.
- **To configure quickly, the 326X Series Modem offers four preconfigured option sets.** Each option set is tailored for an application and stored in the modem’s nonvolatile memory. Refer to the section “Configuration Option Sets” to determine if an option set is appropriate for your application.
- **The following two sections provide examples of common 326X applications and tell you how to configure the modem for each application.** These sections will help you to configure the modem quickly.
- **If you are unfamiliar with the AT command set or the modem front panel**, refer to the section “Remote Access Reset”, later in this chapter. Once this is done, you can use a remote modem to configure the local modem.

If the modem is part of a network and you have a Network Management System (NMS) installed, consult your network manager for configuration information.

Communications Software Package Operating Notes

This section provides information for configuring the 326X Series Modem to work with communications software packages.

Configuring the Modem for Use with Communications Software

Select the Modem’s Preconfigured Option Set 1

Option Set 1 (the modem’s factory default setting) is for use with communications software in asynchronous dial applications, where the AT ACU originates calls.

Refer also to:

- “Operating Notes” at the end of this section
- “Configuration Option Sets”

What to Select in the Communications Software Package's Modem Menu List

- 1) Select **Telenetics 3260 Modem, Codex 3260 Modem, Motorola 3260 Modem**, or another 3260 option from the package's modem list. Packages that directly support the 326X Series Modem support industry-standard commands *and* Telenetics-enhanced commands, making further configuration unnecessary.
- 2) If a **3260** option does not appear in the list, contact the software manufacturer for the latest version of the package (which should have such an option).
- 3) Select a Hayes-Compatible entry. With this option, Telenetics-enhanced commands (AT*) are not supported.
- 4) Try operating the communications software. If you have problems, refer to the "Operating Notes" section, next, and to Chapter 6, Troubleshooting Guide.

Operating Notes

Keep the following in mind when using the modem with communications software.

General Notes

The information in this section applies to all 326X Series Modem platforms.

Selecting an Option Set

Option Set 1 was designed for use with asynchronous communications software packages. It is compatible with most communications software. Option Sets 2, 3, and 4 are intended for different applications and have different default settings. Select Option Set 1 when using a communications software package.

Establishing a Connection with Option Set 1

With Option Set 1, the modem operates as follows:

- 1) The modem attempts to establish a LAPM connection.
- 2) If the connection is unsuccessful, the modem attempts to establish an MNP connection.
- 3) If the previous connections are unsuccessful, the modem attempts a Normal mode connection to the remote modem. All data that is sent to the modem's attached computer terminal before the modem establishes a connection is lost.

Auto Dialing and Answering in Option Set 1

When the modem is configured for Option Set 1, and the communications software package executes an auto dialing and answering operation, the modem automatically adjusts its baud rate to the communications software baud rate and parity. This rate remains constant during the established connection.

Direct Operating Mode

If you select **Mode=Direct** (EC/DC OPT'S category):

- Speed conversion and flow control are not supported. If the communications package does not support speed detect, change the 326X's modulation mode to **Auto V.32**, and after a connection is established, change the communications software rate to match the modem's connection rate.
- If the communications package supports data rates higher than 9.6 kbps, set the modem's maximum rate (**Max Rate**, AT*MX) to the higher rate and disable the adaptive rate feature before placing or answering calls. Ensure that the package's speed and the modem's connection rate match when the connection is established. **NOTE:** Some communications software packages support the automatic speed detect feature, which automatically matches the modem's baud rate with the software package's baud rate.

Transferring a File

Refer to the communications package instructions for the procedure for transferring files using the communications software package's supported protocols.

Ring Messages

Some communications packages wait for ring messages to be received before the modem answers incoming calls. The 326X Series Modem must be set to the communications software package's baud rate before the package recognizes the ring message. Set **DTE Rate**, by the front panel or by issuing an AT command, when the modem is configured for autobaud operations.

Flow Control Requirements

- Flow control prevents buffer overflow when line disturbances cause frequent retransmissions. See "AT*FL" (for the DTE) and "AT*MF" (for the modem) in Appendix A.

If the communications package does not directly support the 326X Series Modem and you want to use the package's file transfer method:

- If the communications package supports RTS/CTS flow control, enable it:
 - a) Set the modem to **Flow=RTS/CTS**
 - b) Set **Modem Flow=Off**
 - c) Transfer data, using the instructions in the communications package.
- If the communications package does *not* support RTS/CTS flow control:
 - a) Set the modem to **Flow=Off**
 - b) Set **Modem Flow=Off**
 - c) Transfer data, using the instructions in the communications package.
- If the communications package supports the automatic speed detect feature, set **Max Rate** to a value also supported by the software package. Set **Speed Conver=Off**. Set the modem's adaptive rate parameter to Off.

326XFAST V.34 and 326XFAST-SDC Notes

The information in this section applies when operating at the higher DTE rates available with the 326XFAST V.34 and 326XFAST-SDC Series Modems.

- If the communications software package supports the higher terminal rates available with these modems, and you want to use the package's auto dial or auto answer features, set the modem's **DTE Rate** (TERMINAL OPT'S category) to that of the package.
- Some communications packages do not let you select the higher rates available with the 326XFAST V.34 modem while using the package's auto dial or auto answer functions. To take advantage of the higher DTE rates, do the following:
 - a) Set the package for Direct or Terminal mode.
 - b) Select the higher speed of the package.
 - c) Set the modem's **DTE Rate** to match the package's set speed.
 - d) Use the AT command set to establish the connection.
- Some file transfer protocols offered by a communications package may not operate properly when **DTE Rate** is greater than 38.4 kbps, because some serial ports cannot sustain data transmission at these rates.





If the Communications Software and Modem Do Not Operate...

If, after following the suggestions in this section, you cannot get the communications software package and modem to operate, refer to Chapter 6, Troubleshooting Guide. If you still cannot get the communications software package and modem to operate, contact your software vendor for assistance.

Preparing for Operation

The procedures in this chapter assume that you are installing the modem for the first time. If you want to reinstall the modem, perform the procedure(s) below to reinitialize the modem's memory. **NOTE:** Reinitializing modem memory sets modem parameter options back to factory defaults (Option Set 1) and deletes stored telephone numbers from memory.

Reinitializing Memory from the Front Panel

- 1) Press  twice. Press  until the modem displays **Reinit Memory**.
- 2) Press . The modem displays **Reinit Mem?**
- 3) Press  to reinitialize modem memory.

Reinitializing Memory Using the AT&F Command

You can also reinitialize memory by entering **AT&F<CR>** from the terminal.

Configuration Option Sets

This section discusses the modem's preconfigured option sets, in three parts:

- What is an Option Set?
- How to Configure an Option Set
- Option Set Defaults—326X V.32bis, 326XFAST V.34, and 326XFAST-SDC

What is an Option Set?

Option sets are complete configurations, each tailored for an application and stored in memory. Option sets get the modem working quickly.

If an option set does not exactly suit your needs, pick the one that most closely matches your application, modify its settings, and save the changes in the modem's nonvolatile memory (refer to Appendix A).

Table 4-1 shows V.32bis and V.34 option sets. Table 4-2 shows SDC option sets.

Table 4-1.
Option Set Summary—326X V.32bis and V.34 Modems

Application	Option Set
Async dial applications in which you are using the AT ACU to originate calls to a central site (default option set)	1
Sync central site auto-answer applications; no ACU	2
Sync calls to a central site	3
Async central site auto-answer applications; no ACU (Models 3260/62/65/67)	4
Leased line application with dial restoral; no ACU (Models 3261/63/66/68)	4

Table 4-2.
Option Set Summary—326XFAST-SDC Modem

Application	Option Set
Async dial applications in which you are using the AT ACU to originate calls to a central site (default option set)	1
Sync dial A/B restoral application	2
Sync dial only application	3
Sync leased line application with dial restoral; no ACU (Models 3261/63/66/68)	4

Option Set Descriptions—326X V.32bis and V.34 Modems

Option Set 1—Async Calls to Central Site Using the AT ACU

With Option Set 1, the modem communicates over dial lines using an asynchronous data format. This option set is appropriate for home or office use where you plan to dial, for example, into a central-site computer, minicomputer, an electronic bulletin board, or a personal computer. When you first install the modem, it is set to power up with Option Set 1 as the factory default. The modem recognizes the standard AT Command Set and the Telenetics-enhanced AT Command set.

To satisfy common asynchronous communications software packages, Option Set 1 holds several EIA 232-D (ITU V.24) control signals asserted (see Tables 4-1 and 4-2). The modem originates calls and answers incoming calls according to the setting of S-Register 0 (see the “S-Registers” section in Chapter 5 for more information).

At the beginning of each connection, the modem negotiates the highest common data rate with the remote modem set to its factory default setting or automode. The modem also uses the adaptive rate feature in the V.34, V.32bis, or V.32 modulation modes. This ensures maximum throughput when line quality is poor.

Option Set 2—Sync Answering Central Site Without an ACU

Option Set 2 satisfies the needs of a synchronous application where most calls are to a central site (see Table 4-1).

Because calls are received primarily at the central site, the modem is set to answer calls automatically. With **DTR=108.2**, the local DTE can control the DTR signal. This allows the local DTE to use DTR transitions to connect the modem to the central site at the beginning of transmission and disconnect it when transmission ends.

At the beginning of each connection, the modem negotiates the highest common data rate with the remote modem. The modem uses the adaptive rate feature in the V.34, V.32bis, or V.32 modulation modes. This ensures maximum throughput when line quality is poor.

Option Set 3—Sync Calls to Central Site Using the V.25bis ACU

Option Set 3 satisfies the needs of a synchronous application, where the remote modems originate calls to a central site (see Table 4-1).

With Option Set 3, the modem originates calls with its V.25bis ACU. The DTR option is set to 108.2 so that the V.25bis ACU can manipulate the DTR signal. All other options in the ACU OPT'S category are set for a typical synchronous DTE.

At the beginning of each connection, the modem negotiates the highest common data rate with the remote modem. The modem uses the adaptive rate feature in the V.34, V.32bis, or V.32 modulation modes. This ensures maximum throughput when line quality is poor.

Option Set 4—Async Answering Central Site Without an ACU (Models 3260/62/65/67)

Option Set 4 satisfies the needs of an asynchronous application where most calls are inbound (see Table 4-1).

Because calls are received primarily at the central site, the modem is set to answer calls automatically. With **DTR=Discon**, the local DTE can control the DTR signal. This allows the local DTE to use DTR transitions to connect the modem to the central site at the beginning of transmission and disconnect it when transmission ends. The DTR signal from the DTE must be high for the modem to auto-answer. If the DTR signal is low, it does not answer incoming calls.

At the beginning of each connection, the modem negotiates the highest common data rate with the remote modem. The modem uses the adaptive rate feature in the V.34, V.32bis, or V.32 modulation modes. This ensures maximum throughput when line quality is poor.

Option Set 4—Sync Leased Line Applications With Dial Restoral (Models 3261/63/66/68)

Option Set 4 uses the modem's leased line restoral feature. With this option set, the modem operates primarily on a leased line unless that line fails. If so, the modem automatically restores the connection over a single dial line. You must install a 326X Series Modem at both ends of the leased line to implement restoral operation.

Option Set 4 configures the modem for a general restoral application (see Table 4-1). The modem uses the adaptive rate feature in the V.34 or V.32bis Auto modes. This ensures maximum throughput when line quality deteriorates. If restoral criteria are met, the modem automatically reroutes data traffic through the public switched telephone network (PSTN) over a single dial line. At that time, the modem attempts to run at its maximum rate over the dial line, and falls back to lower speeds if required. After an hour, the modem returns to the leased line.

If you operate your modems in leased-line mode with Option Set 4, and *one* modem has software Revision 7.8 or 7.9, set the **Fast Call** parameter (AT*FC, Modulation Opts Menu) to Off in *both* modems.

Option Set Descriptions—326XFAST-SDC Modems

Option Set 1—Async Calls to Central Site

Option Set 1 in the 326X-SDC product functions the same as Option Set 1 above.

Option Set 2—Sync Dial A/B Restoral

Option Set 2 satisfies the needs of a synchronous point-to-point digital link restoral application (see Table 4-2).

With this option set, the **Clock** is set to External as network timing is provided by the DSU/CSU. **NOTE:** With this option set, (for Telenetics and Motorola DSU/CSUs as well as non-Telenetics and non-Motorola DSU/CSUs), the DSU's restoral configuration should be set to **Timing=Internal**.

With this option set, the local and remote modems are configured for SDC operation. The modems default to **Fast Call=Lvl3**, and use LAPM error correction with modified V.42bis data compression. Enable Option Set 2 in both the local and remote modems, and ensure that **Mode** (AT*SM) is set *the same* in both modems.

The modem uses the adaptive rate feature in the V.34 Auto modulation mode. This ensures maximum throughput when line quality is poor.

Option Set 3—Sync Dial Only

Option Set 3 satisfies the needs of a synchronous dial application (see Table 4-2). With Option Set 3, the modem provides the network timing (**Clock=Internal**). Select a data rate at which the modem communicates with the DTE, using **DTE Rate** (AT*DE). Consult the description in Appendix A.

With this option set, the local and remote modems are configured for SDC operation. The modems default to **Fast Call=Lvl3**, and use LAPM error correction with a modified V.42bis data compression. Enable Option Set 3 in both the local and remote modems, and ensure that **Mode** (AT*SM) is set *the same* in both modems.

With Option Set 3, **DTR=108.1** so that an off-to-on DTR transition instructs the modem to connect to the telephone line. If the modem detects an incoming call, the call is connected. If the modem does not detect an incoming call and **Default Dial** (AT*DA) is enabled, the modem dials the number specified. If **Default Dial** is disabled, the modem refers to the **Modulation Mode** option (AT*MM). If set to Answer, the modem goes off-hook and sends an answer-back tone. An on-to-off DTR transition disconnects the modem from the telephone line. If DTR is low, the modem does not auto-answer. DTR transitions govern how the modem answers and disconnects calls. All options in the ACU OPT'S category are set for a typical synchronous DTE.

The modem uses the adaptive rate feature in the V.34 Auto modulation mode. This ensures maximum throughput when line quality is poor.

Option Set 4—Sync Leased Line with Dial Restoral; No ACU (Models 3261/63/66/68)

Option Set 4 uses the modem's leased line restoral feature. With this option set, the modem operates primarily on a leased line unless that line fails. If so, the modem automatically restores the connection over a single dial line. You must install a 326XFAST-SDC Modem at both ends of the leased line to implement restoral.

Option Set 4 configures the modem for a general restoral application (see Table 4-2). The modem uses the adaptive rate feature in the V.34 Auto modulation mode. This setting ensures maximum throughput when line quality deteriorates. If restoral criteria are met, the modem automatically reroutes data traffic through the public switched telephone network (PSTN) over a single dial line. At that time, the modem attempts to run at 28.8 kbps over the dial line, and falls back to lower speeds if required. After an hour, the modem returns to the leased line.

With Option Set 4, the modem provides the network timing (**Clock=Internal**). Select a data rate at which the modem communicates with the DTE, using **DTE Rate** (AT*DE). Refer to the description in Appendix A.

In this option set, the local and remote modems are configured for SDC operation. The modems default to **Fast Call=Lvl3**, and use LAPM error correction with modified V.42bis data compression. Enable Option Set 4 in both the local and remote modems, and ensure that **Mode** (AT*SM) is set *the same* in both modems.

Refer to “326X V.32bis and 326XFAST Modem Application Examples” below.

If you operate your modems in leased-line mode with Option Set 4, and *one* modem has software Revision 7.8 or 7.9, set the **Fast Call** parameter (AT*FC, Modulation Opts Menu) to Off in *both* modems.

Configuring an Option Set

This section describes how to configure and save an option set.

From the Modem Front Panel:

- 1) Read “Preparing for Operation,” earlier in this chapter.
- 2) Identify the option set for your application. The default is Option Set 1.
- 3) Display **SELECT OPTIONS** on the front panel (refer to Chapter 2 to review the function of front panel control keys).
- 4) Press ▼ until the modem displays **SELECT OPTIONS:n**, where $n=1-4$.
- 5) Press Ⓞ to select an option set. The modem displays **SELECT OPTIONS=n**.

Using the ATZ Command:

- 1) Read “Preparing for Operation,” earlier in this chapter.
- 2) Identify the option set for your application. The default is Option Set 1.
- 3) Type **ATZn<CR>**, where $n=1-4$.

NOTE: The modem disconnects from the line when the ATZ command is entered, and any test in progress is immediately terminated. Since any AT command following the ATZ command is ignored by the modem, make sure ATZ is the last command entered in the command string.

To create a customized option set:

Using the AT&W Command:

- 1) Using the ATZn command, select an option set n that most closely suits the application.
- 2) Use AT commands (see Appendix A) to change parameter options. For example, to change RTS/CTS delay from its time in S-Register 26, to 15 ms, enter **AT*DL1<CR>**. The front panel displays **OK**.
- 3) Enter **AT&Wn**, where n specifies the address (option set) where the new customized option set is stored.

The front panel displays **SAVING OPTIONS**.

- 4) After a few seconds, your modifications are stored in the modem’s nonvolatile memory, and the modem front panel displays **SAVE COMPLETED!**
- 5) Do not turn off modem power until **SAVE COMPLETED!** appears.

From the Modem's Front Panel:

- 1) Identify the option set that most closely suits the application. The default is 1.
- 2) Display the option(s) you want to modify using ▼ and ►. For example, to change **Max Rate** from 2400 to 7200, display **Max Rate: 7200**.
Press Ⓞ. The display flashes three times and the colon changes to an equals sign. The new option is temporarily saved and **Max Rate=7200** displays.
- 3) Step across the Status/Option Sets/Dialing menu by pressing ► until you see: **Save Changes=n**.
- 4) Use the ▼ key to display the option set number where you want the changes saved, and then press Ⓞ. The modem displays **Saving Options**.
- 5) After a few seconds, the modifications are stored in the modem's nonvolatile memory, and the modem displays **SAVE COMPLETED!**
- 6) Do not turn off modem power until **SAVE COMPLETED!** appears.

Option Set Defaults

Table 4-3 summarizes option set defaults for 326X V.32bis and 326XV.34 modems.

Table 4-4 summarizes option set parameter defaults for 326X V.34-SDC modems.

Table 4-3.
Option Set Defaults—326X V.32bis and 326X V.34 Modems

<i>Parameter</i>	<i>Option Set 1</i>	<i>Option Set 2</i>	<i>Option Set 3</i>	<i>Option Set 4 (3260/62/65/67)</i>	<i>Option Set 4 (3261/63/66/68)</i>
MOD OPT'S					
Line	Dial	Dial	Dial	Dial	2W Lease
Mod*	V.32bis Auto/ V.34 Auto	V.32bis Auto/ V.34 Auto	V.32bis Auto/ V.34 Auto	V.32bis Auto/ V.34 Auto	V.32bis Auto/ V.34 Auto
Auto Type	CCITT	CCITT	CCITT	CCITT	CCITT
Low Speed	Country-specific	Country-specific	Country-specific	Country-specific	Country-specific
Max Rate*	14.4/ 33.6	14.4/ 33.6	14.4/ 33.6	14.4/ 33.6	14.4/ 33.6
Min Rate	300	300	300	300	300
V.34 Asym	[none]/On*	[none]/On*	[none]/On*	[none]/On*	[none]/On*
Fast Call	Off	Off	Off	Off	Off
Adaptive Rate	On	On	On	On	On
Mode	Originate	Answer	Originate	Answer	Answer
Clock	Internal	Internal	Internal	Internal	Internal
Retrain	High BER	High BER	High BER	High BER	High BER
Longspace	Off	Off	Off	Off	Off
PSTN	On	On	On	On	On
Guard Tone	Country-specific	Country-specific	Country-specific	Country-specific	Country-specific

**V.32bis Series default shown first/V.34 Series default shown second*

Table 4-3.
Option Set Defaults—326X V.32bis and 326X V.34 Modems (Continued)

Parameter	Option Set 1	Option Set 2	Option Set 3	Option Set 4 (3260/62/65/67)	Option Set 4 (3261/63/66/68)
RESTORAL OPT'S (modems without the restoral function display only the HOLD DIALINE option)					
Restore	Off	Off	Off	Off	FP/Auto
L to D	Low/Fast	Low/Fast	Low/Fast	Low/Fast	Low/Fast
D to L	Manual	Manual	Manual	Manual	1 Hr
Hold Dialine	Off	Off	Off	Off	Off
Ans Rest	LL Fail	LL Fail	LL Fail	LL Fail	LL Fail
EC/DC OPT'S					
Mode	Auto Rel	Direct	Direct	Auto Rel	Direct
Buffers	Regular	Regular	Regular	Regular	Regular
EC	V.42	V.42	V.42	V.42	V.42
DC	Enabled	Enabled	Enabled	Enabled	Enabled
Break	Destruct	Destruct	Destruct	Destruct	Destruct
Modem Flow	On	On	On	On	On
Delay	Off	Off	Off	Off	Off
EC ID	Default	Default	Default	Default	Default
ACU OPT'S					
ACU Select	AT	None	V.25b	None	None
AT Form	Async	Async	Async	Async	Async
V25 Form	Bitsync	Bitsync	Bitsync	Bitsync	Bitsync
NoACU Form	Async	Sync	Sync	Async	Sync
Default Dial	Off	Off	Off	Off	1
Answer	Country-specific	Country-specific	Country-specific	Country-specific	Country-specific
Async Echo	On	On	On	On	On
Char Length	10	10	10	10	10
V25 Char	ASCII	ASCII	ASCII	ASCII	ASCII
Sync Idle	Char	Char	Char	Char	Char
V25 Resp	V25bis	V25bis	V25bis	V25bis	V25bis
Parity	V.25bis	V.25bis	V.25bis	V.25bis	V.25bis
AT Msg	Before CD	Before CD	Before CD	Before CD	Before CD
Rslt Code	Enable	Enable	Enable	Enable	Enable
ResltForm	Verbose	Verbose	Verbose	Verbose	Verbose
Con Msg	DTE Rate	DTE Rate	DTE Rate	DTE Rate	DTE Rate
Rel Msg	Off	Off	Off	Off	Off
LPDA2 Addr	FF	FF	FF	FF	FF
LPDA2 ID	326X	326X	326X	326X	326X
LPDA2 Det	Enable	Enable	Enable	Enable	Enable
Call Progress	4	4	4	4	4

**V.32bis Series default shown first/V.34 Series default shown second*

Table 4-3.
Option Set Defaults—326X V.32bis and 326X V.34 Modems (Continued)

Parameter	Option Set 1	Option Set 2	Option Set 3	Option Set 4 (3260/62/65/67)	Option Set 4 (3261/63/66/68)
TERMINAL OPT'S					
DTE Rate*	Auto	14.4/28.8	14.4/28.8	19.2	14.4/28.8
Flow	XON/XOFF	XON/XOFF	XON/XOFF	XON/XOFF	XON/XOFF
Speed Conver	On	On	On	On	On
DTR	High	108.2	108.2	Discon	High
RTS	High	Normal	Normal	Normal	Normal
CTS	AsynSync	Normal	Normal	Normal	Normal
RTS/CTS Delay	0	0	0	0	0
DCD	High	Normal	Normal	Normal	Normal
RemRST/DCD	Codex	Codex	Codex	Codex	Codex
DCD Loss Dis	S10	S10	S10	S10	S10
DSR	High	Drop on Disc	Normal	Normal	Normal
Overspeed	1%	1%	1%	1%	1%
DTR Delay	S25	S25	S25	S25	S25
DTE Ct 140	Off	Off	Off	Off	Off
DTE Ct 141	Off	Off	Off	Off	Off
DTE Pin 25	Test	Test	Test	Test	Test
Ext Select	Off	Off	Off	Off	Off
Ext Cntrl	Pin 14	Pin 14	Pin 14	Pin 14	Pin 14
Inactivity	S30	S30	S30	S30	S30

**V.32bis Series default shown first/V.34 Series default shown second*

Table 4-4.
Option Set Defaults—326X-SDC V.34 Modem

Option	Option Set 1	Option Set 2	Option Set 3	Option Set 4 (3261/63/66/68)
MOD OPT'S				
Line	Dial	Dial	Dial	2W Lease
Mod	V.34 Auto	V.34 Auto	V.34 Auto	V.34 Auto
Auto Type	CCITT	CCITT	CCITT	CCITT
Low Speed	Country-specific	Country-specific	Country-specific	Country-specific
Max Rate	33.6	33.6	33.6	33.6
Min Rate	300	9600	9600	9600
V.34 Asym	On	On	On	On
Fast Call	Off	Lvl3	Lvl3	Lvl3
Adaptive Rate	On	On	On	On
Mode	Originate	Answer	Originate	Answer
Clock	Internal	External	Internal	Internal
Retrain	High BER	High BER	High BER	High BER
Longspace	Off	Off	Off	Off
PSTN	On	On	On	On
Guard Tone	Country-specific	Country-specific	Country-specific	Country-specific
RESTORAL OPT'S				
Restore	Off	Off	Off	FP/Auto
L to D	Low/Fast	Low/Fast	Low/Fast	Low/Fast
D to L	Manual	Manual	Manual	1 Hr
Hold Dialine	Off	Off	Off	5min
Ans Rest	LL Fail	LL Fail	LL Fail	LL Fail
EC/DC OPT'S				
Mode	Auto Rel	Auto Rel	Auto Rel	Auto Rel
Buffers	Regular	Regular	Regular	Regular
EC	V.42	V.42	V.42	V.42
DC	Enabled	Enabled	Enabled	Enabled
Data Form	NRZ	NRZ	NRZ	NRZ
Break	Destruct	Destruct	Destruct	Destruct
Modem Flow	On	On	On	On
Delay	Off	Off	Buff or S38	Off
EC ID	Default	Default	Default	Default
ACU OPT'S				
ACU Select	AT	None	None	None
AT Form	Async	Async	Async	Async
V25 Form	Bitsync	Bitsync	Bitsync	Bitsync
NoACU Form	Async	Sync	Sync	Sync
Default Dial	Off	1	1	1

Table 4-4.
Option Set Defaults—326X-SDC V.34 Modem (Continued)

Option	Option Set 1	Option Set 2	Option Set 3	Option Set 4 (3261/63/66/68)
Answer	Country-specific	Country-specific	Country-specific	Country-specific
Async Echo	On	On	On	On
Char Length	10	10	10	10
V25 Char	ASCII	ASCII	ASCII	ASCII
Sync Idle	Char	Char	Char	Char
V25 Resp	V25bis	V25bis	V25bis	V25bis
Parity	V.25bis	V.25bis	V.25bis	V.25bis
AT Msg	Before CD	Before CD	Before CD	Before CD
RsIt Code	Enable	Enable	Enable	Enable
ResItForm	Verbose	Verbose	Verbose	Verbose
Con Msg	DTE Rate	DTE Rate	DTE Rate	DTE Rate
Rel Msg	Off	Off	Off	Off
LPDA2 Addr	FF	FF	FF	FF
LPDA2 ID	326X	326X	326X	326X
LPDA2 Det	Enable	Enable	Enable	Enable
Call Progress	4	4	4	4
TERMINAL OPT'S				
DTE Rate	Auto	56.0 U.S. A., Canada 64.0 other countries	56.0 U.S. A., Canada 64.0 other countries	56.0 U.S. A., Canada 64.0 other countries
Flow	XON/XOFF	Tx Clk	Tx Clk	Tx Clk
TpDlyMin	—NA—	Rx Clk	Rx Clk	Rx Clk
Speed Conver	On	On	On	On
DTR	High	Tail	108.1	High
RTS	High	Normal	Normal	Normal
CTS	AsynSync	Normal	Normal	Normal
RTS/CTS Delay	0	0	0	0
DCD	High	Normal	Normal	Normal
RemRST/DCD	Codex	Codex	Codex	Codex
DCD Loss Dis	S10	S10	S10	S10
DSR	High	Normal	Normal	Normal
Overspeed	1%	1%	1%	1%
DTR Delay	S25	S25	S25	S25
DTE Ct 140	Off	Off	Off	Off
DTE Ct 141	Off	Off	Off	Off
DTE Pin 25	Test	Test	Test	Test
Ext Select	Off	Off	Off	Off
Ext Cntrl	Pin 14	Pin 14	Pin 14	Pin 14
Inactivity	S30	S30	S30	S30

326X V.32bis and 326XFAST Modem Application Examples

This section provides application examples for each option set, and notes options you may need to change from factory default settings for each option set.

<i>For This Type of Application...</i>	<i>Select...</i>
The modem connected to a remote terminal dialing into an asynchronous host computer (VAX, for example)	Option Set 1
The modem connected to a remote PC dialing into a LAN (remote node and remote control application)	Option Set 1
Remote X-Terminal dialing to a UNIX workstation or PC into a central site (for example, a UNIX-based terminal server or mini-computer)	Option Set 1
The modem connecting LANs via dial-up router/bridge	Option Set 1
The modem connected to a terminal calling an X.25 network or an electronic bulletin board	Option Set 1
The modem as an answer modem connected to one of the following: <ul style="list-style-type: none"> • A Front End Processor (FEP) or host computer • An X.25 host/node • Asynchronous router/bridge 	Option Set 2
Cluster controller calling a host computer	Option Set 3
Synchronous terminal calling a host computer	Option Set 3
Router/bridge calling another router/bridge	Option Set 3
X.25 node/host computer calling another X.25 node/host computer	Option Set 3
The modem as an external restoral device for leased line failure	Option Set 3
Bandwidth on demand for leased line applications	Option Set 3
Synchronous Dialing from an IBM AS 400	Option Set 3
The modem as an answer modem connected to one of the following: <ul style="list-style-type: none"> • An electronic bulletin board • An asynchronous host computer • A terminal server • An asynchronous dial-up router/bridge 	Option Set 4 (Models 3260/ 62/65/67)
The modem connecting routers/bridges on a leased line	Option Set 4 (Models 3261/ 63/66/68)
The modem connecting an FEP to a cluster controller	Option Set 4 (Models 3261/ 63/66/68)
The modem connecting two FEPs	Option Set 4 (Models 3261/ 63/66/68)
X.25/statistical multiplexer internodal with dial restoral	Option Set 4 (Models 3261/ 63/66/68)

Option Set 1—Async Calls to Central Site Using AT ACU

Changing Default Configuration Settings

Depending on application requirements, you may need to change the following:

- **Buffer Delay** (AT*DB, EC/DC OPTS category), when enabled, allows buffered data in the communications link to be effectively transmitted to the other modem before the modems disconnect. Enable this feature if your application *does not* ensure a complete transfer of data before the modems disconnect.
- When the 326X is configured for Option Set 1: if you do not use the AT ACU to send commands to operate the modem, you must customize the DTE port by selecting these options:
 - **DTE Rate**. Set the modem's DTE rate to match the asynchronous DTE's rate using the **DTE Rate** option (AT*DE, TERMINAL OPTS category).
 - **Parity**. Set the modem's parity to match the parity set in the asynchronous DTE using the **Parity** option (AT*RP, ACU OPTS category).
 - **Character Length**. Set the modem's character length (**Char Length**, ACU OPTS category) to match the length set in the asynchronous DTE.

(Refer to Appendix A for parameter and setting descriptions.)

- In Option Set 1, the default settings assume you will use the AT ACU to operate the modem (for example, the default for **ACU Select=AT**; EIA signals are set high). If you plan on using DTR transitions (“DTR Dialing”) to signal the modem to make a call (rather than AT Commands), do the following:
 - 1) Set **Default Dial=1** (AT*DA, ACU OPTS category).
 - 2) Store a number in memory location 1 (using **Enter Phone #**, AT&Z, 9600 T/D? category).
 - 3) Set **DTR=108.1** (AT&D, TERMINAL OPTS category). When DTR is raised, the modem will dial the specified call.
- If the DTE does not require EIA signal pins to be held high, adjust the EIA settings (TERMINAL OPTS category) to match your application requirements.
- In Option Set 1, the modem is set for XON/XOFF (software) flow control. If your application requires hardware flow control, change the **Flow** setting (AT*FL, TERMINAL OPTS category).

Option Set 2—Sync Answering Central Site Without ACU

Changing Default Configuration Settings

Depending on application requirements, you may need to change the following:

- In Option Set 2, the default for network timing is **Clock=Internal** (AT&X, MODULATION OPTS category). It may be necessary to change the timing to external or loopback, depending on the network clocking source.
- In Option Set 2, the default for **ACU Select=None**. If you want an ACU to operate the modem, select an ACU and a data format.
- Customize the DTE port as follows:
 - Set the modem's DTE rate to match the synchronous DTE's rate using **DTE Rate** (AT*DE, TERMINAL OPTS category) (refer to Appendix A for parameter and setting descriptions.)
- The default **Answer** option is country-specific. Refer to Appendix C to verify that this option is appropriate for your application.
- If the DTE does not provide DTR, the modem will not automatically answer an incoming call. Set **DTR=High** (AT&D, TERMINAL OPTS category).

Option Set 3—Sync Calls to Central Site, V.25bis ACU

Changing Default Configuration Settings

Depending on application requirements, you may need to change the following:

- In Option Set 3, the default setting for network timing is **Clock=Internal** (AT&X, MODULATION OPTS). It may be necessary to change the timing to external or loopback, depending on the network clocking source.
- In Option Set 3, the default setting for **ACU Select=None**. If you want an ACU to operate the modem, select an ACU and a data format.
- Customize the DTE port by selecting this option:
 - Set the modem's DTE rate to match the synchronous DTE's rate using the **DTE Rate** option (AT*DE, TERMINAL OPTS).
 - (Refer to Appendix A for parameter and option descriptions.)
- If you plan on using DTR transitions (“DTR Dialing”) to signal the modem to make a call (rather than issuing commands from an ACU), do the following:
 - 1) Set **Default Dial=1** (AT*DA, ACU OPTS category).
 - 2) Store a number in memory location 1 (using **Enter Phone #**, AT&Z, ATAT 9600 T/D? category).
 - 3) Set **DTR=108.1** (AT&D, TERMINAL OPTS category). When DTR is raised, the modem will dial the specified call.

Synchronous Dialing from an IBM AS 400

The modem operates as a synchronous originate modem with the IBM AS 400. **Set the modem to Option Set 3—no reconfiguration from this Option Set is necessary.** The AS 400 supports switched operation with call origination via a V.25bis compliant call establishment driver. Using Option Set 3 allows it to be driven by APPC/APPN, the bit-synchronous protocol supported by the IBM AS 400.

In an AS 400-to-AS 400 (mainframe-to-mainframe) environment, the setting of the Calling Number parameter is critical to ensure the AS 400 operates properly with the modem. Rather than entering the phone numbers you will be calling, set **CALLNBR** to ***NONE**. This setting allows you to properly utilize V.25bis commands.

Chapter 3, Automatic Calling Interfaces, in the *326X Series Modem Reference Guide*, describes bit-synchronous protocol frame formats.

Option Set 4—Async Answering Central Site without ACU (Models 3260/62/65/67)

Changing Default Configuration Settings

Depending on application requirements, you may need to change the following:

- The Buffer Delay feature (AT*DB, EC/DC OPTS category), when enabled, allows buffered data in the communications link to be effectively transmitted to the other modem before the modems disconnect. Enable this feature if your application *does not* ensure a complete transfer of data before the modems disconnect.
- The default **Answer** option is country-specific. Refer to Appendix C to verify that this option is appropriate for your application.
- In Option Set 4, the default option for **ACU Select**=None. If you want an ACU to operate the modem, select an ACU and a data format.
- If you do not use the AT ACU to send commands to operate the modem, customize the DTE port as follows:
 - Set the modem's DTE rate to match the asynchronous DTE's rate using **DTE Rate** (AT*DE, TERMINAL OPTS category).
 - Set the modem's parity to match the parity set in the asynchronous DTE using **Parity** (AT*RP, ACU OPTS category).
 - Set the modem's character length, using **Char Length** (ACU OPTS category) to match the character length in the asynchronous DTE.

(Refer to Appendix A for parameter and setting descriptions.)

- In Option Set 4, the modem is set for XON/XOFF (software) flow control. If your application requires hardware flow control, change the **Flow** option (AT*FL, TERMINAL OPTS category).
- If the DTE does not provide DTR, the modem will not automatically answer an incoming call. Set **DTR**=High (AT&D, TERMINAL OPTS category).

Option Set 4—Synchronous Leased Line Applications with Dial Restoral (Models 3261/63/66/68)

Changing Default Configuration Settings

Depending on application requirements, you may change the following options:

- The default **Restoral** setting in Option Set 4 (leased line models) is Auto/FP. When first configuring the modem, set **Restoral=Off**. This prevents erroneous status errors from displaying while you configure leased line options. After configuration, if your application requires automatic initiation of dial restoral, set **Restoral=Auto/FP**.
- When installing the modem in a leased line application, the default **Mode** setting (AT*CA, MODULATION OPTS category) is Answer. **For proper operation, you must set Mode=Answer in one modem, and Mode=Originate in the other modem.**
- Depending on application requirements, you may change the following:
 - **Line (MODULATION OPTS)**. Default option is 2W Lease. Can also be set for 4W Lease application.
 - **No ACU Form (ACU OPTS)**. Default option is Sync. Can be set to Async.
 - **Answer (ACU OPTS)**. Default option is country-specific. Refer to Appendix C to verify that this option is appropriate for your application.
 - **Restoral (RESTORAL OPTS)**. Default option is Auto/FP (as described above). Can be set to Off to disable restoral.
 - **Clock (MODULATION OPTS)**. Default option is Internal. Can be set to external or loopback, depending on the network clocking source.
 - **DTE (TERMINAL OPTS)**. If **No ACU Form=Async**, customize your DTE port by selecting these options:
 - Set the modem's DTE rate to match the asynchronous DTE's rate using **DTE Rate** (AT*DE, TERMINAL OPTS category).
 - Set the modem's parity to match the parity set in the asynchronous DTE using **Parity** (AT*RP, ACU OPTS category).
 - Set the modem's character length to match the character length set in the asynchronous DTE, using **Char Length** ACU OPTS category)
 - (Refer to Appendix A for parameter and setting descriptions.)

326XFAST-SDC Modem Application Examples

This section provides application examples for each SDC option set, and notes options you may need to change from factory default settings for each option set. This section includes the following:

- **SDC Pre-Operation Notes**—read this *before* configuring the modem
- **Configuring The Modem for SDC Operation**—configuration options that are *critical* to ensure optimum network performance on an SDC connection
- **SDC Sample Applications**—examples of common SDC applications

SDC Pre-Operation Notes

This section contains important information for using the 326XFAST-SDC Modem in SDC operating mode. *Read this section before configuring the unit.*

Operational Requirements

- 326XFAST-SDC modems require framed HDLC/SDLC-like data. **NOTE:** BER tests do not operate in an SDC environment because the data is not framed.
- 326XFAST-SDC modems support an NRZ or NRZI data encoding method. Refer to the DTE documentation for information on the data encoding method the DTE supports. (Refer to Appendix A, **Data Form** [AT*DF] option, for details on NRZ/NRZI data encoding methods.)

Optimizing Network Performance

The 326XFAST-SDC modem provides front panel displays of RX/TX Throughput and Link Utilization. Higher values indicate more efficient utilization; lower values indicate less efficient usage. These values are affected by the attached DTE and protocol characteristics—frame size, window size, and DTE rate selected.

(Refer to Chapter 1 of the *326X Series Modem Reference Guide* for a description of how to use the RX/TX Throughput and Link Utilization displays.)

Telenetics recommends the following to maximize efficiency:

- If your application is operating in a windowed protocol environment, set the window sizes to greater than 1 to improve performance. Recall that windowing refers to the number of packets sent before an acknowledgment is required.
- To improve network performance, adjust frame sizes. The optimum frame size for most applications is between 128 and 1024 bytes. Experiment with window and frame sizes for maximum performance.
- If link utilization is low, raise the DTE rate. Low link utilization typically implies that the DTE equipment is the bottleneck in data transmission.

Configuring the Modem for SDC Operation

You can configure the 326XFAST-SDC Modem for SDC in one of these ways:

- Select Option Set 2, 3, or 4Leased, discussed below
- Configure the modem as follows:
 - Select one of the reliable data transfer modes (Reliable, Auto Reliable, or Speed Auto Reliable).
 - Choose an Auto-Call Unit (ACU)—AT, V.25bis, LPDA, or None—using the **ACU Select** option, ACU OPT'S category.
 - Select a bit-synchronous data format (depending on the ACU type).

Refer to Appendix A for additional information on each of these methods.

Ensuring Optimum Network Performance in SDC Mode

The following parameters are critical for ensuring optimum network performance:

- **Fast Call** (AT*FC)
- **DTE Rate** (AT*DE)
- **Flow** (AT*FL)
- **TpDlyMin** (AT*TD)

Table 4-4 shows 326X-SDC option set default settings.

Carefully note the following when configuring the modem for SDC operation:

- **Fast Call.** Both modems must be configured *the same* in order to connect. If one of the modems does not support Fast Call, change the default setting to Off.
- **DTE Rate.** For better link utilization and throughput, higher values than the default may be appropriate. (Refer to the **DTE Rate** description in Appendix A.) Refer to “Optimizing Network Performance” in the preceding section for more information.
- **Flow/TpDlyMin.** The default options assume the DTE can accept nondisruptive clock stoppage. For DTEs that cannot handle Rx/Tx clock stoppage without disrupting data, select a different option. In this situation, Telenetics recommends that the default values *not* be used.

SDC Sample Applications

SDC Option Set 1—Async Calls to Central Site Using AT ACU

SDC Option Set 1 functions the same as described above for non-SDC modems. Refer to that section for application examples.

SDC Option Set 2—Sync Dial A/B Restoral

Single Channel Point-to-Point Digital Link Restoral (via A/B Switch)

When used as a dial backup device for a digital network, the SDC modem provides economical dial backup and/or disaster recovery, at synchronous speeds matching speeds available on the DDS circuit.

When used as a restoral device for Telenetics and Motorola 35XX DSU/CSUs (Figure 4-1), **select SDC Option Set 2** in the local and remote SDC Modems. This places the modems in external timing, as digital services typically provide the network timing.

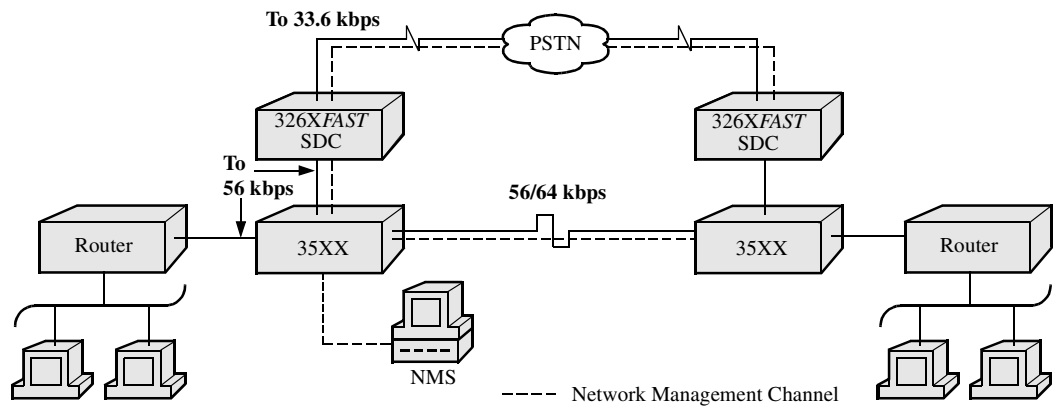

Figure 4-1. Single Channel Point-to-Point Digital Link Restoral (A/B Switch)—Option Set 2

Note the following:

- With SDC Option Set 2 selected (for Telenetics, Motorola, non-Telenetics, and non-Motorola DSU/CSUs), the DSUs' restoral configuration should be set to **Timing=Internal**.
- In this case, the 326XFAST-SDC **DTE Rate** must be set to a constant rate as provided by the network (defaults of 56/64 kbps).
- Enable Option Set 2 in both the local and remote modems, and ensure that **Mode** (AT*SM) is set *the same* in both modems.
- The SDC modem supports single channel environments only. For example, the SDC modem can restore Port 1 *only* of the 35XX device.
- The 35XX device, when initiating restoral, must be set to Normal mode (as the 35XX network management channel is virtually a time division multiplexed data stream which cannot be compressed with the SDC product).
- The SDC modem may have the ARS feature enabled. In this case, ARS determines the link rate.

Figure 4-2 shows a configuration using an external A/B switch. Network configuration (SDC Option Set 2) and operation is the same as with an internal switch.

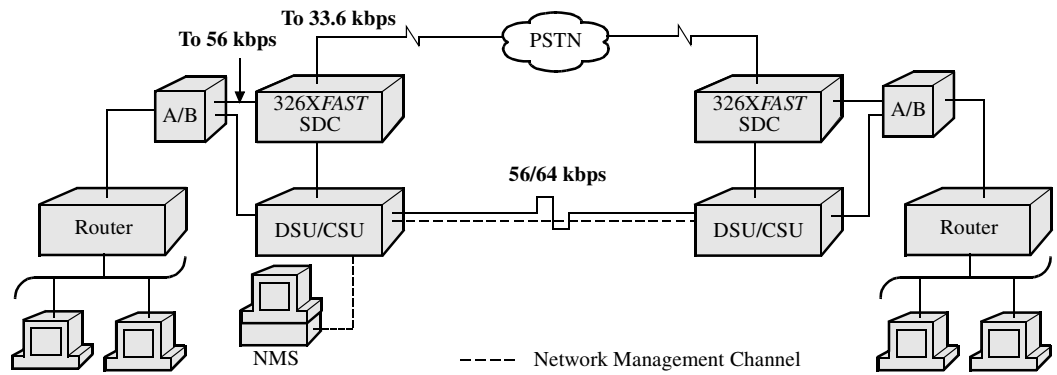

Figure 4-2. Single Channel Point-to-Point Digital Link Restoration (A/B Switch)—Option Set 2

SDC Option Set 3—Sync Dial Only

In a typical dial application, a remote terminal dials the host for file transfers. This allows remote users to dial in as needed, with a higher throughput than formerly attainable over the PSTN. Alternately, the DTE and host (Figure 4-3) could be nodal equipment (e.g., X.25 PADs, routers, bridges). In this configuration, the SDC modems are used for remote dial-up branch connectivity. This is useful for remote uploading or downloading data over the PSTN as needed.

Select **SDC Option Set 3** for either of these applications.

Note the following:

- With Option Set 3, the modem provides the network timing (**Clock=Internal**).
- Specify the speed at which the modem communicates with the DTE using the **DTE Rate (AT*DE)** option, to use a value other than the default. See the **DTE Rate** description in Appendix A.
- With Option Set 3, the modem originates calls with its V.25bis ACU. DTR is set to 108.1 so that an off-to-on DTR transition instructs the modem to connect to the telephone line. If the modem detects an incoming call, the call is connected. If the modem does not detect an incoming call and you have enabled **Default Dial (AT*DA)**, the modem dials the number specified. If the **Default Dial (AT*DA)** is disabled, the modem refers to the **Mode** option (**AT*AC**). If set to answer, the modem goes off-hook and sends an answer-back tone. An on-to-off DTR transition disconnects the modem from the telephone line. If DTR is low, the modem does not auto-answer. DTR transitions govern how the modem answers and disconnects calls.
- If you want the V.25bis ACU to manipulate the DTR signal, set **DTR=108.2**. Other options in the ACU OPT'S category are set for a typical sync DTE.
- Select SDC Option Set 3 in both the local and remote modems, and ensure that **Mode (AT*SM)** is set *the same* in both modems.
- The modem uses the adaptive rate feature in the V.34 Auto modulation mode. This ensures maximum throughput when line quality is poor.

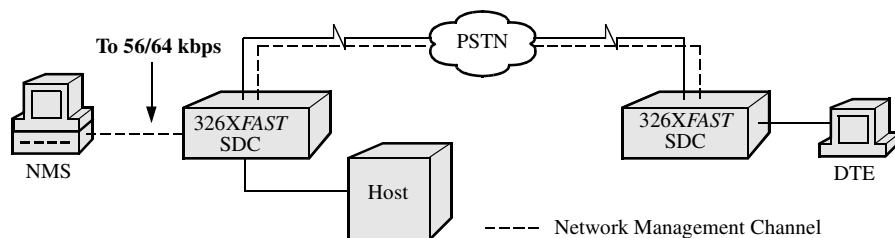

Figure 4-3. 326X-SDC Dial-Only Application—Option Set 3

Bandwidth On Demand

Bandwidth on demand is often required to support sporadic peak loads. With the SDC modem, you can ensure full network availability and performance at low dial-up line costs, without having to prioritize users or applications.

Figure 4-4 shows a point-to-point digital link with Telenetics 35XX DSU/CSUs connecting two routers over a DDS circuit. The SDC modems are also connected directly to the routers. During peak network access periods, the router is configured to signal the SDC modem to establish a dial connection through the PSTN. Users transparently bypass the digital link, using the 326XFAST-SDC PSTN link to continue data transmission. As bandwidth demands subside, the dial call is dropped, and transmission resumes over the DDS link.

The SDC modem supports all industry-standard ACUs (AT, V.25bis, DTR dialing, and LPDA-2). Bandwidth on demand can be initiated/terminated under the control of the nodal equipment by a secondary port. **NOTE:** Nodal equipment must be configured for secondary port restoral/bandwidth on demand operation. Refer to the nodal equipment documentation for instructions on configuring for this application.

Select SDC Option Set 3 for a bandwidth on demand application. All operational information described in the preceding section, “SDC Option Set 3—Sync Dial Only”, applies to this application.

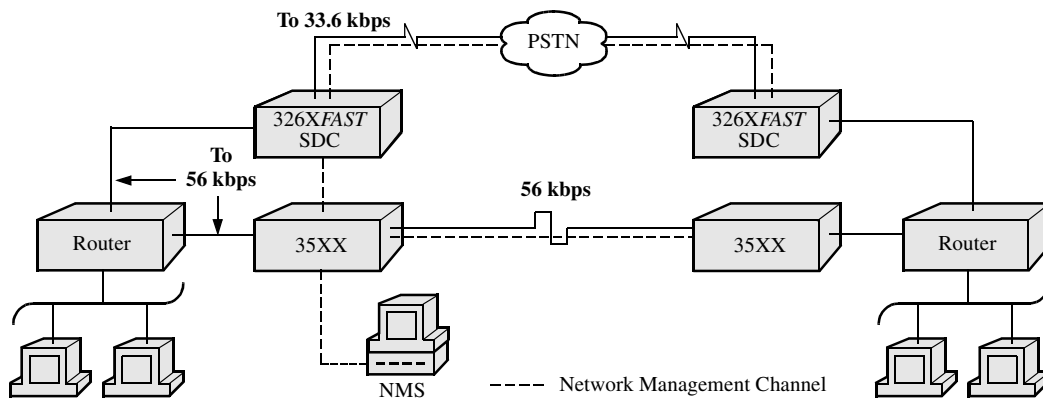

Figure 4-4. Bandwidth On Demand—Option Set 3

SDC Option Set 4—Sync Leased Line with Dial Restoral; N oACU (Models 3261/63/66/68)

Point-to-Point Leased Line Application with Dial Restoral

Figure 4-5 shows a typical point-to-point leased line application, with SDC modems providing leased line and dial back-up for a bridge/router network. A Telenetics Network Management System (NMS) is shown. This application could apply to any nodal equipment connections (e.g., bridges, routers, or X.25 PADs).

With the modem's integral restoral capabilities, if leased circuit operation is disrupted, the modems restore the connection over a single dial line through the PSTN.

The modem uses the adaptive rate feature in the V.34 Auto modulation mode. This ensures maximum throughput when line quality deteriorates. If restoral criteria are met, the modem automatically reroutes data traffic through the PSTN. At that time, the modem attempts to run at its maximum rate over the dial line, and falls back to lower speeds if required. After an hour, the modem returns to the leased line.

Select SDC Option Set 4 for this application.

Note the following:

- The line configuration default of Option Set 4 is Two-Wire Leased Line.
- With Option Set 4, the modem provides the network timing (**Clock**=Internal).
- To specify a non-default rate at which the modem communicates with the DTE, use the **DTE Rate** (AT*DE). See the **DTE Rate** description in Appendix A.
- Select SDC Option Set 4 in both the local and remote modems, and ensure that **Mode** (AT*SM) is set *the same* in both modems.
- If operating with the Telenetics or Motorola 6500^{PLUS} that has the Link Back-Up option, set **DTR**=108.2 (the default is 108.1 for 6500s without the Link Back-Up option).

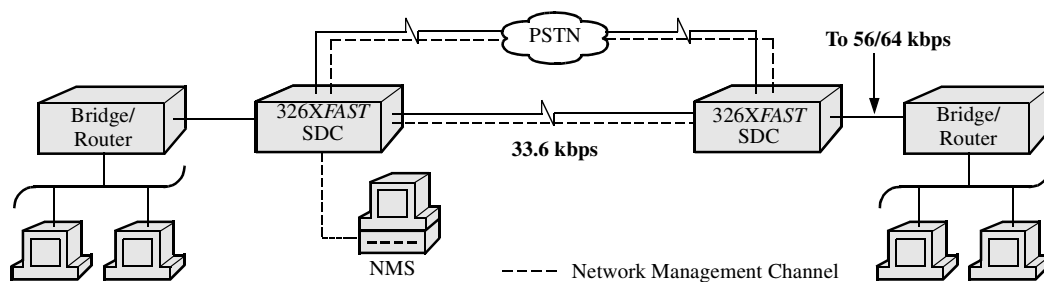



Figure 4-5. Point-to-Point Leased Line Application with Dial Restoral—Option Set 4

Remote Access Reset

Remote access reset enables someone unfamiliar with the AT command set to quickly configure a local modem so that another modem can dial into it. Then you can use the remote modem to configure local modem options. Remote access reset configures the modem to:



- Answer an incoming call
- Accept a network management session
- Accept a remote configuration session initiated by the calling modem
- Disconnect a call if one is in progress
- End any test in progress

Operation

To select remote access reset, press  and  simultaneously for three seconds. **Rmt Access Reset** displays. The modem resets itself to settings that let it answer a call and be accessed by an NMS or remote modem. The modem may be dialed into and reconfigured. Stored phone numbers and saved option sets remain unchanged.

When Remote Access Reset Is Disabled

Remote access reset is not supported when the modem is attached to a network management system. If you select it in this situation, **NETMAN ATTACHED!** displays. To invoke remote access reset, set **OverrideMode=On** (NETWK CTRL OPT'S).

Remote access reset is not supported when the modem is password protected (i.e., when pressing  and  for three seconds displays **PASSWD PROTECTED**). To choose the remote access feature, you must first unlock the modem, either from the front panel, or with the AT*PN (enter password) command.

Chapter 5

Using the AT Automatic Calling Interface

Contents

Introduction	5-2
What is the Attention (AT) Command Set?	5-3
What Role Does Communications Software Play?	5-3
Using AT Commands	5-3
Entering AT Command Lines	5-3
Autobaud Feature	5-5
The Escape Sequence—(+++)	5-5
Non-Configuration AT Commands	5-6
S-Registers	5-9

Introduction

The 326X Series Modem supports an asynchronous AT Automatic Calling Interface (Auto-Call Unit or ACU), that is compatible with the *industry-standard AT* command set.

AT commands provide a standard modem communications interface, allowing you to configure and operate a modem from an asynchronous terminal or PC keyboard. AT commands define how the modem is configured, how it makes calls, and the test operations the modem performs. In addition to supporting *industry standard AT* commands, Telenetics has developed an *enhanced AT* command set for the modem.

- *Industry-Standard AT Command Set—AT and AT&*

These commands, called *action AT* commands, are intended for immediate modem action and let you perform day-to-day operations, such as dialing and storing numbers from your asynchronous DTE. These AT commands do not cross-reference to the modem front panel.

- *Telenetics Enhanced AT Command Set—AT**

Using these Telenetics AT extensions, you can also configure most modem options. These AT commands, called *configuration AT* commands, control the same options as in your modem's front panel menu tree.

This chapter discusses:

- The AT Command Set
- Using AT commands
- *Action AT* commands
- S-Registers

For an alphabetized quick-reference list of AT commands, corresponding front panel options, and command functions, see Appendix A.

The 326X Series Modem supports two additional ACUs:

- V.25bis ACU, for asynchronous and synchronous applications
- LPDA2 ACU, for synchronous applications

For details, refer to Chapter 3 in the *326X Series Modem Reference Guide*.

If you are using communications software, you normally *do not* use the AT command set directly. Your communications software will do this for you.

What is the Attention (AT) Command Set?

The AT command set is a collection of commands that let you configure a modem directly from an asynchronous terminal or PC keyboard. The characters **AT** are a prefix to the commands you issue to your modem. When you type AT, you are asking for the modem's *attention*. For instance, to disconnect a telephone call, you type **AT** for attention and **H0** for on-hook (hang up).

You can also use AT commands to configure a remote modem (refer to Chapter 2, Front Panel Operation, of the *326X Series Modem Reference Guide* for details).

What Role Does Communications Software Play?

Some communications software packages “interpret” AT commands with pull-down menus or graphics, making familiarity with the AT command syntax unnecessary.

Communications software packages that directly support the 326X Series Modem usually support all of the modem's AT commands (the industry standard commands AT, AT&, and the Telenetics-enhanced commands AT*).

Communications software packages that support a Hayes-compatible selection do not support the Telenetics-enhanced commands (AT*). You can enter these commands yourself to modify option settings if required by your application.

Check the documentation included with your communications software package to determine whether you need to use AT commands directly.

Using AT Commands

AT commands are accepted by the modem in *command mode* or *escape mode*.

- The modem is in *command mode* when it is disconnected from the telephone line.
- You can enter *escape mode* and issue AT commands during a connection (the escape sequence +++ is described later in this chapter).

Entering AT Command Lines

To enter a single AT command line:

- 1) *Enter the prefix AT:* The characters **AT** (upper-case or lower-case, but not mixed) must begin the command line.
- 2) *Enter an AT command. For example:*
 - **D** instructs the modem to dial a call. **H** instructs the modem to hang up. A numeric character (for example, **2**) following an AT command instructs the modem to use a specific command option. If a numeric character is not indicated, the modem assumes the **0** (zero) option.
- 3) *End with a carriage return <CR>.*

The exceptions to the above AT command line conventions are “A” (repeat last command) and “+++” (the escape sequence). Responses (result codes) to AT commands always appear in upper-case.

To enter multiple AT commands on a single command line:

Multiple AT commands can be entered on a command line using a single AT prefix. The modem accepts up to 60 characters after the prefix. Spaces are not counted in the length. AT commands are interpreted in sequence in the command line until one of the following occurs:

- A <CR> is encountered
- An invalid command is encountered
- A command is encountered which causes the modem to reset, go off-hook, or enter a test state

For example, you might enter:

ATE0V1&W<CR>

on a single command line. This command disables Asynchronous Echo. It configures the Result Code Format to Verbose, and the Save Changes feature to Option Set 1. (These options and settings are described fully in Appendix A.)

Commands that are followed by a telephone number must be at the end of the line. However, if the semicolon dial modifier (;) follows a telephone number, the modem returns to command mode after dialing. Therefore, AT commands can be entered after a semicolon in a command string. **NOTE:** If an error occurs, AT commands prior to the error are executed; commands following the error are ignored.

If you enter an AT command that requires a postscript number and no number is entered, the modem defaults to a 0 setting.

AT Command String Examples

Table 5-1 provides AT command string examples and their ACU results.

Table 5-1.
Interpreting AT Command Strings

Command	Interpretation
AT&X<CR>	Postscript number needed and none is provided. 0 is assumed. Transmitter timing is set for internal.
ATS2	No response. Needs a carriage return after the command.
GATE0<CR>	Ignores everything before the AT prefix. The G is ignored. This command disables the asynchronous echo feature.
ATS2?Q=1<CR>	Multiple command line. Selects S-Register 2 as the current S-Register, displays contents of S-Register 2, turns on result code displays, and sets S-Register 2 to 1.

For Further Detail on AT Commands

For a description of AT commands, and dial modifiers, refer to Appendix xA.

Autobaud Feature

The modem automatically detects the speed and character format of the following AT commands issued from your DTE:

- AT
- at
- A/
- a/

This means that any AT command you issue to the modem will cause the modem to “Autobaud.” The exception is the lower-case “a/” and upper-case “A/”, from which only speed can be detected. When the a/ or A/ commands are issued, the modem assumes parity to be the same as that of the previous command.

NOTE: Autobaud does not operate when the modem is online in escape mode.

Autobauding works at the following DTE rates (bps):

300	1200	2400	4800	7200	9600
12,000	14,400	16,800	19,200	21,600	24,000
26,400	28,800	38,400	57,600	115,200	

Table 5-2 summarizes the 10-bit-total character formats for autobauding. (Autobauding is valid only with 10-bit character formats.)

Table 5-2.
Valid Autobauding Character Formats

Start Bit	Data Bits	Parity	Stop Bits
1	7	Even or Odd	1
1	7	None	2
1	7	Mark or Space	1
1	8	None	1

Result codes, such as RING, are sent at the last autobauded DTE speed and parity. CONNECT result codes are also sent at the last autobauded DTE speed, even if the call is established at a different speed. When the modem is turned on, the last autobauded speed is saved. Because parity is saved within option sets, the parity value that is saved in the power-up option set is the one that is active.

The Escape Sequence—(+++)

The escape sequence is used when the modem is online and you need to enter commands to the modem without disconnecting. The escape sequence with guard time protects against losing the connection while you send commands.

NOTE: Autobaud does not operate when the modem is in escape mode.

Once in command state, you can:

- Terminate a call
- Initiate and terminate a test
- Issue AT action commands
- Change your modem’s configuration
- Initiate a remote configuration session
- Read modem status using the AT*ST command

The escape state is entered by sending the escape character three consecutive times. The escape character is selectable as any ASCII character. Its value is stored in S-Register 2, and the default is “+” (decimal 43). To disable escape command detection, set S-Register 2 to a value greater than 127.

A guard time is used with the escape sequence. A guard time must precede and follow the sequence of escape characters to prevent the +++ characters from inadvertently placing the modem into command mode if they are transmitted in a message. If data is sent within the guard time, the escape sequence is not detected. The default guard time is one second.

The guard time specified by S-Register 12 also specifies the maximum time between the three consecutive escape characters. If more than the allowable time elapses between escape characters, the escape sequence is ignored. Setting S-Register 12 to zero disables the guard time, so that the rate at which you enter the escape sequence is not a factor.

To use the escape sequence with guard time:

- 1) *Pause a bit longer than the guard time.*
- 2) *Send +++, ensuring the delay between +’s is less than the specified guard time.*

When a valid escape sequence is detected, the modem responds with

OK

Do *not* send commands until the OK response has been received. A command that is sent too soon may not be interpreted correctly.

- 3) *Pause again, a bit longer than the guard time.*
- 4) *Enter commands to the modem.*
- 5) *When you are ready to resume the call to the remote system, type ATO<CR>. The modem returns to the online state.*

When using error correction, if you “escape” from the data state to the command state, the modem buffers any data received from the remote site. When you return online (to data state), the buffered data is sent to the DTE.

Non-Configuration AT Commands

Most AT commands cross-reference to a front panel option. Some AT commands are intended only for immediate modem action. These commands allow you to perform a number of the important day-to-day modem functions, such as:

- Re-execute your last command
- Answer an incoming call
- Dial a telephone number
- Hang up
- Exit command mode, return to data mode
- Redial the last telephone number

This section addresses AT commands that *do not* cross-reference to a front panel option.

A/, Re-Execute Last Command

Settings: Not applicable

Format: A/

This command re-executes the last AT command string issued to the modem, including redialing a telephone number. To re-execute the last command, enter A/ *but* do not follow this command with <CR>.

The A/ command may be entered in either uppercase or lowercase characters. However, when entered in lowercase characters, the modem cannot use the autobaud feature to determine parity. The modem continues to use the parity determined by the previous command. The AT*ZD (Dial Rstrct) AT command limits the A/ command.

The modem does not support auto-parity for this command.

ATA, Manual Answer

Settings: Not applicable

Format: ATA<CR>

This command instructs the modem to go off-hook and send answer-back tone over the line. When the ATA command is used during an incoming call, the modem initiates the “answer” end of the modulation mode handshake sequence. DSR transitions from off to on when the answer-back tone is sent if DSR is not configured for the High setting. If the modem is using error correction, the error-correction link handshake takes place after the modulation mode handshake, and before DCD (if DCD is not configured for the High setting) transitions from off to on.

This command causes the modem to answer a call regardless of the contents of S-Register 0 (Ring Count to Answer On).

If the ATA command is issued while the modem is in escape mode or in remote configuration, the modem responds with:

ERROR

ATD, Dial

To dial directly from the keyboard, enter ATD followed by the number you want to dial. For example:

ATD1-617-555-1212<CR>

The ATD command causes the modem to go off-hook, dial the number, and execute all dial modifiers in the dial string. The type of call progress message you see is controlled by the **Call Progress** (ATX) setting. The modem can dial up to 50 characters, including spaces.

In originate mode, if the ATD command is issued without a phone number, the modem goes off-hook.

If ATD is issued while the modem is in escape mode or remote configuration, the modem responds with:

ERROR

NOTE: Any invalid characters inserted into the dial string will be ignored.

ATH, Hang Up

Settings: 0, Modem hangs up
1, Busy Out the modem

Format: ATHn<CR>

You may hang up the modem after entering the online escape mode by typing ATH or ATH0. Typing ATH1 while in command mode causes the modem to Busy Out until either the ATH command is entered or the Ⓢ key is pressed. **NOTE:** For busy out, make certain that the TELCO OPT'S Telco option is set for RJ4MB.

ATI, Display Software Information

Settings: 0, Displays 960
1, Displays 000
2, Displays OK
9, Displays reason for last disconnect

Format: ATIn<CR>

The messages described above are displayed in addition to the “OK” sent when AT command processing is complete. **NOTE:** If this command is the last or only command in a command line, an additional “OK” message follows the above responses.

ATO, Leave Command Mode

Settings: 0, Leave command mode and return online
1, Leave command mode, return online, and initiate a retrain

Format: ATOn<CR>

This command can be used only when the modem is in the online escape mode, or after a “;” (semicolon) dial modifier in a dial string.

The user may leave escape mode and return to data mode by typing ATO or ATO0. If a retrain is desired while returning to data mode, ATO1 must be used.

If this command is issued while the modem is disconnected from the phone line, the modem responds with:

NO CARRIER

If this command is issued while the modem is in a remote configuration session, the modem responds with:

ERROR

NOTE: If the ATO command is issued after a “;” (semicolon) dial modifier (return to command state after dialing), the modem trains as an originate modem.

AT*RD, Redial Last Number

Settings: 0, 1 Redial last number one time.

n (The maximum number of redials allowed is country-specific. See the *326X Series Modem Country-Specific Guide* for more details).

Format: AT*RDn<CR>

You may redial a failed call *n* times using the AT*RD command. The modem redials a call until a successful connection is made, or until the call has been attempted *n* times. The AT*RD command causes the modem to redial the *last* number dialed. So if an initial call fails, and the telephone number is linked to another number, the modem redials the linked telephone number.

S-Registers

S-registers are memory locations for storing specific configuration and operating parameters. S-registers typically contain timing, counting, ASCII characters, or command option values. While communications software generally insulates you from the need to alter S-register settings, you may want to reconfigure or read the contents of an S-register. This section describes how to read and change S-Register values.

This section is in two parts:

- The first part describes the AT commands used to display and change S-Register values.
- The second part describes S-Registers used by the modem.

Any S-Register that is not stored in memory is reset to its default value when you:

- Power up the modem
- Load a new Option Set
- Reinitialize memory

Displaying and Changing S-Register Values

Display S-Register Value (ATS*n*?)

Settings: *n*, Specifies S-Register

Format: ATS*n*?<CR>

This command displays the value of S-Register *n*, as stored in volatile memory.

If a “?” appears in the command string anywhere other than immediately following the S-Register number, the command displays the value of the last S-Register selected.

If you try to read the value of an unused S-Register, the modem displays **OK**.

Display S-Register Value (AT?)

Settings: Selected S-Register

Format: AT?<CR>

This command displays the contents of the “selected” S-Register, as stored in volatile memory. The “selected” S-Register is the last S-Register that was accessed using an S-Register command or the ATSn command. The number must be within the S-Register’s specified range. On power-up, S-Register 0 is “selected.”

If you try to read the contents of an unused S-Register, the modem displays **OK**.

Change S-Register Value (ATSx=n)

Settings: *n*, Specifies S-Register

x, Specifies value of S-Register

Format: ATSn=x<CR>

This command lets you change the value of an S-Register stored in volatile memory. *n* is the S-Register to change, and *x* is the value. *x* must be a number within the S-Register’s range.

If you try to change the value of an unused S-Register, the modem displays **OK**.

Change S-Register Value (AT=x)

Settings: *x*, Specifies value of selected S-Register

Format: AT=x<CR>

This command lets you change the value of an S-Register stored in volatile memory. The “selected” S-Register is the last S-Register that was accessed using an S-Register command or the ATSn command. *x* must be a number within the specified range for the S-Register. On power-up, S-Register 0 is “selected.”

If you try to change the value of an unused S-Register, the modem displays **OK**.

S-Register Descriptions

S-Register 0—Ring Count to Answer On

Stored in Nonvolatile Memory?: Yes

Status-Only?: No

Default Setting: 0

Range: 0 to 255

This S-Register specifies the ring on which the modem automatically answers a call. When set to 0, automatic answering is disabled, and calls must be answered manually. This register has no meaning unless **Answer=Using S0 (ACU OPT’S)**.

S-Register 1—Ring Count

<i>Stored in Nonvolatile Memory?:</i>	No
<i>Status-Only?:</i>	Yes
<i>Default Setting:</i>	0
<i>Range:</i>	0 to 255

This S-Register counts the number of rings in an incoming telephone call. If the modem is configured to answer (AT*AA, or **Answer=S0**), when S-Register 1's value equals S-Register 0's value, the modem answers the call. If no ring is received after a country-specific time (eight to 10 seconds), the counter is reset to 0.

S-Register 2—Escape Code Character

<i>Stored in Nonvolatile Memory?:</i>	Yes
<i>Status-Only?:</i>	No
<i>Default Setting:</i>	43
<i>Range:</i>	0 to 255

This S-Register determines the decimal value of the escape code character. The default setting, 43, translates to the ASCII “+” character. Values greater than 127 disable the escape function.

S-Register 3—Carriage Return Character

<i>Stored in Nonvolatile Memory?:</i>	No
<i>Status-Only?:</i>	No
<i>Default Setting:</i>	13
<i>Range:</i>	0 to 127

This S-Register determines the decimal value of the carriage return character. The default setting, 13, translates to the ASCII <CR> (carriage return) character.

S-Register 4—Line Feed Character

<i>Stored in Nonvolatile Memory?:</i>	No
<i>Status-Only?:</i>	No
<i>Default Setting:</i>	10
<i>Range:</i>	0 to 127

This S-Register determines the decimal value of the line feed character. The default setting, 10, translates to the ASCII <LF> (line feed) character.

S-Register 5—Backspace Character

<i>Stored in Nonvolatile Memory?:</i>	No
<i>Status-Only?:</i>	No
<i>Default Setting:</i>	8
<i>Range:</i>	0 to 127

This S-Register determines the decimal value of the backspace character. The default setting, 08, translates to the ASCII <BS> (backspace) character. Values greater than 32 (except 127) disable the backspace function.

S-Register 6—Wait for Dial Tone

<i>Stored in Nonvolatile Memory?:</i>	Yes
<i>Status-Only?:</i>	No
<i>Default Setting:</i>	2
<i>Range:</i>	1 to 255 (seconds)

If **Call Progress** is set to 0, 1, or 3 (ATX0, ATX1, ATX3), and blind dial is selected, the modem does not look for a dial tone. Instead, the modem goes off-hook and waits for the number of seconds specified by S-Register 6 before blind dialing a telephone number (if **Blind Dial** is set to S6, AT*BD2). This S-Register does not affect the wait dial modifiers W, w, or :.

S-Register 7—Wait for Data Carrier

<i>Stored in Nonvolatile Memory?:</i>	Yes
<i>Status-Only?:</i>	No
<i>Default Setting:</i>	30
<i>Range:</i>	1 to 255 (seconds)

If **Call Timeout** (AT*TT) is set to S7, the value of S-Register 7 determines the number of seconds that the modem waits for a carrier signal from the remote modem after dialing or answering a call.

S-Register 7 also affects the dial modifiers @, W, w, and :.

Dial Modifier “@”

If **Call Timeout** (AT*TT) is set to S7, the value of S-Register 7 determines the length of time for which the @ dial modifier instructs the modem to detect five seconds of silence.

Dial Modifier “W”, “w”, and “:”

If the **Dial Wait** option (AT*DD) is set to S7, the value of S-Register 7 determines the value of the dial wait modifier. The dial wait modifier determines how long the modem waits for a second dial tone after the modem has dialed a number.

S-Register 8—Pause Time for Pause Delay Dial Modifiers

<i>Stored in Nonvolatile Memory?:</i>	Yes
<i>Status-Only?:</i>	No
<i>Default Setting:</i>	2
<i>Range:</i>	0 to 255 (seconds)

This S-Register determines how many seconds the modem pauses while dialing when it encounters a K, k, “,” or < dial modifier. **Pause Delay** (AT*DP) must be set to S8 (AT*DP4) to use S-Register 8’s setting.

This S-Register also determines the time duration of the pause delay for the “,” character when used in an AT command string. The modem pauses for the specified time before continuing to process the command string.

With the “,” k, K, or < dial modifier, if S-Register 8 is set to 0 or 1, the pause delay defaults to two seconds.

S-Register 10—Carrier Loss Hang Up Delay

<i>Stored in Nonvolatile Memory?:</i>	Yes
<i>Status-Only?:</i>	No
<i>Default Setting:</i>	15
<i>Range:</i>	1 to 255

S-Register 10 determines how long, in 100 millisecond increments, data carrier must be lost before the modem hangs up. **NOTE:** This applies to V.22bis, B212, V.21, and B103 operation only. To use S-Register 10’s setting, the front panel DCD Loss Dis option (AT*CD) must be set to S10. Also, if S-Register 10 is set to 255, the modem will not hang up because of a carrier loss.

Setting the AT*CD (**DCD Loss Disconnect** option under the TERMINAL OPT’S menu) to S10 enables the DCE disconnect feature, for V.32, V.32bis, and V.34 modulation modes. For these modes, the S-Register 10 determines the length of time, in seconds, for the modem to disconnect when the remote modem goes on hook without sending a longspace or PSTN clear-down.

In Normal or Direct modes, S10 must be set between 1–9 seconds. For Reliable mode, S10 must be set between 1–8 seconds. These selections result in Disconnect in the specified time after the modem leaves data mode and starts to retrain. Values of S10 other than the ones specified above disable the DCE Disconnect feature.

S-Register 11—DTMF Tone Duration

<i>Stored in Nonvolatile Memory?:</i>	Yes
<i>Status-Only?:</i>	No
<i>Default Setting:</i>	72
<i>Range:</i>	50 to 255 (country-specific)

S-Register 11 defines the duration/spacing of tones (in milliseconds) in DualTone Multifrequency (DTMF) dialing. This register has no meaning unless the Tone Length option under the DIALING OPT'S is set to S11. Refer to Appendix C, Country-Specific Information, for the ranges supported by each country.

S-Register 12—Escape Code Guard Time

<i>Stored in Nonvolatile Memory?:</i>	No
<i>Status-Only?:</i>	No
<i>Default Setting:</i>	50 (1 second)
<i>Range:</i>	0 to 255

This S-Register sets the interval that must be present on either side of the escape code (+++) in order for the modem to recognize the escape command and enter command mode. This prevents the +++ characters from putting the modem in command mode if they are contained in data. The value of S-Register 12 is multiplied by 0.02 to determine the number of seconds. For example, the value of the factory default 50 is one second.

If S-Register 12 is set to 0, the speed at which you enter the escape sequence is not a factor.

S-Register 18—Test Timer

<i>Stored in Nonvolatile Memory?:</i>	Yes
<i>Status-Only?:</i>	No
<i>Default Setting:</i>	0
<i>Range:</i>	0 to 255 (seconds)

This S-Register determines the duration, in seconds, of loopback tests. With S-Register 18 set to 0, the timer is not operational and tests must be terminated manually. **NOTE:** S-Register 18's function is valid only when loopback tests are issued using the AT&T command. S-Register 18 cannot be used to automatically terminate loopback tests if the test is initiated from the front panel.

S-Register 25—Delay Before Looking for DTR

<i>Stored in Nonvolatile Memory?:</i>	Yes
<i>Status-Only?:</i>	No
<i>Default:</i>	5
<i>Range:</i>	0 to 255 (seconds)

When **DTR Delay**=S25 (AT*DT), and **AT Form**=Sync Data (AT&M) or **V25 Form**=AsynSync, the modem goes into synchronous data mode after the modem dials asynchronously. S-Register 25 lets you switch from an asynchronous DTE to a synchronous DTE without hanging up. S-Register 25 allows this switch by specifying how many seconds the modem waits after connecting before looking for DTR.

S-Register 26—RTS/CTS Delay

<i>Stored in Nonvolatile Memory?:</i>	Yes
<i>Status-Only?:</i>	No
<i>Default:</i>	1
<i>Range:</i>	0 to 255

This S-Register selects the delay between CTS and RTS while the modem is online. It operates in modes specified by the RTS (AT*RS) and CTS (AT*CT) commands.

The time is selectable in 1/100 second intervals, from 0 to 2.55 seconds.

S-Register 30—DTE Inactivity Disconnect

<i>Stored in Nonvolatile Memory?:</i>	Yes
<i>Status-Only?:</i>	No
<i>Default:</i>	0
<i>Range:</i>	0 to 255 (x 10 seconds)

If **DTE Inactivity**=S30 (AT*SI), the modem disconnects when data is not sent or received for an amount of time greater than the value stored in S-Register 30, multiplied by 10 seconds. Time-outs range from 10 to 2550 seconds (42.5 minutes). A value of 0 stored in S-Register 30 disables the DTE inactivity option.

S-Register 38—Disconnect Buffer Delay

<i>Stored in Nonvolatile Memory?:</i>	Yes
<i>Status-Only?:</i>	No
<i>Default:</i>	5
<i>Range:</i>	0 to 255 (seconds)

S-Register 38 determines how long the modem processes buffered data when a disconnect is initiated. For S-Register 38 to affect the **Delay** option (AT*DB), **Delay** (EC OPT'S menu) must be set to "Buf or S38" or "Buf & S38."

S-Register 45—Access Security Tone Duration

<i>Stored in Nonvolatile Memory?:</i>	Yes
<i>Status-Only?:</i>	No
<i>Default:</i>	5
<i>Range:</i>	0 to 10 (seconds)

This S-Register specifies the prompt tone duration when the ACCESS SECURITY option **Tone**=Prompt Only or Prompt/Ack (AT*ZP). This delay is measured from the time that the prompt tone is generated by the answer modem, to the time that the answer modem detects the first digit of the calling modem's password.

S-Register 46—Access Security Lead Digit Delay Timeout

<i>Stored in Nonvolatile Memory?:</i>	Yes
<i>Status-Only?:</i>	No
<i>Default:</i>	12
<i>Range:</i>	0 to 255 (seconds)

This S-Register specifies the lead digit delay timeout when ACCESS SECURITY **Tone** (AT*ZP) is enabled.

S-Register 96—Signalling System #5

<i>Stored in Nonvolatile Memory?:</i>	Yes
<i>Status-Only?:</i>	No
<i>Default:</i>	0
<i>Range:</i>	0 - 1

This S-Register specifies whether Signalling System #5 is enabled.

S-Register 97—Break Signal Duration

<i>Stored in Nonvolatile Memory?:</i>	Yes
<i>Status-Only?:</i>	No
<i>Default:</i>	0 (represents 1 second)
<i>Range:</i>	0 - 39

<i>S-Register 97 Value</i>	<i>Break Signal Duration (ms.)</i>
0	1000 (1 second)
1	26
2	52
3	78
4	104
5	130
6	156
7	182
8	208
9	234
10	260
11	286
12	312
13	338
14	364
15	390
16	416
17	442
18	468
19	494
20	520
21	546
22	572
23	598
24	624
25	650
26	676
27	702
28	728
29	754
30	780
31	806
32	832
33	858
34	884
35	910
36	936
37	962
38	988
39	1000

S-Register 98—AC Detect

Stored in Nonvolatile Memory?: Yes

Status-Only?: No

Default: 0

Range: 0 - 1

This S-Register applies to V.32bis and V.34 operating modes. It enables and disables AC Tone Protect, which is part of the modem's training sequence.

S-Register 99—V.32 Training Time

Stored in Nonvolatile Memory?: Yes

Status-Only?: No

Default: 0

Range: 0 to 216*

*One unit = 32 baud = 13.5 milliseconds.

This S-Register extends part of the V.32 modulation mode training time. It provides a workaround to an inability of Rockwell-based modems to establish a connection.

Telenetics recommends that with Rockwell-based modems, you set S-99 to 120.

Chapter 6

Troubleshooting Guide

Contents

Introduction	6-2
Troubleshooting	6-2
326X Series Modem Diagnostic Tests	6-10
Synchronous Data Compression (SDC) Testing	6-11

Introduction

Most problems encountered when installing and using the modem can be corrected if you carefully read and follow the instructions in the documentation. Use the Troubleshooting section of this chapter to analyze and correct problems *before* calling Telenetics' Customer Support Center or your local distributor.

The section after the troubleshooting guide tells you how to initiate and terminate tests. Chapter 4 of the *326X Series Modem Reference Guide* contains detailed information on these tests.

Assumptions

- The modem is set to factory default configurations.
- The modem has been installed with all initial cabling complete.

Troubleshooting

This section discusses:

- Dial operation problems
- Synchronous data compression (SDC) mode problems
- Leased line operation problems

The First Step

First, confirm that your data communications application is set up correctly:

- Confirm that your communications software is configured for the correct serial port to which your modem is connected (i.e., COMM1, COMM2, etc.)
- Confirm the COM port is configured for the data rate, word length, and parity your configuration requires
- Confirm that the cable connecting the modem to the host equipment is a DCE-to-DTE straight-through cable
- Confirm the electrical interface of your modem (V.35 or RS-232) and ensure that you have the correct cable installed

Troubleshooting Steps

Use the table that follows to match your problem with a diagnosis and solution.

326X Series Modem Troubleshooting Guide

Problem	Diagnosis/Test	Possible Solution
During installation:		
<i>Modem won't power up</i>	<p>Check AC power.</p> <p>Check modem's power switch.</p>	<p>Ensure AC outlet is active.</p> <p>Turn on power switch.</p>
<i>Modem fails self test (front panel displays error code)</i>	Repeat power-up sequence.	If modem fails once again, call Telenetics' Customer Support or your local distributor and report the error code.
<i>Modem doesn't come up in ready state— "326X Ready" on front panel display</i>	Check DIP Switch #6 on modem's rear panel.	<ul style="list-style-type: none"> • Ensure DIP Switch #6 is in the Off (up) position. • Power cycle the modem.
While operating the 326X as a dial modem:		
ACU CONFIGURATION		
<i>No response to ACU command</i>	<p>Check that TD LED on front panel lights when commands are being sent to the modem.</p> <p>Check modem's configuration:</p> <ul style="list-style-type: none"> • DTE Rate (AT*DE) • ACU Form • Char Length • Parity (AT*RP) • Result Code (ATQ) 	<ul style="list-style-type: none"> • If light does not come on, check that cables are properly connected. • Check the communications software package for correct communications port configuration. • Check that the communications software package's baud rate is set to a rate that the modem's autobaud feature supports. • Ensure ACU is compatible with modem's configuration. • Make sure the DTE is set to a valid character format to operate the modem's autobaud feature (see Chapter 5 for details on this feature). • If modem still does not respond after modifying configuration, perform a local analog loopback (LAL) test. (Refer to the end of this chapter for details on tests supported, as well as instructions for initiating tests.) • If LAL fails, contact Telenetics Customer Support or your local distributor.
<i>Double echo on characters typed</i>	<p>Check echo setting on data terminal equipment and modem.</p> <p>Check the terminal setup of the communications software.</p>	If both echo settings are on, turn one off. (In some data terminals, echo is sometimes referred to as half- or full-duplex.) If this does not solve the problem, contact Telenetics Customer Support or your local distributor.
CALL ESTABLISHMENT		
<i>Modem won't answer</i>	<p>Check the modem's configuration:</p> <ul style="list-style-type: none"> • Answer (AT*AA) • DTR (AT&D) 	<p>Ensure that Answer is not set to Manual.</p> <p>Set DTR=High (AT&D0).</p>

326X Series Modem Troubleshooting Guide (Continued)

Problem	Diagnosis/Test	Possible Solution
	<p>Check the modem's line setting (AT&L).</p> <p>Check that the TR LED on modem's front panel is steady on.</p> <p>Check that the RI/OH LED is on when ring is present on the line.</p> <p>Check that the communications package's data rate is set to a rate that the modem's autobaud feature supports.</p>	<p>Ensure Line=Dial (AT&L0).</p> <p>If the TR LED is not steady on, ensure the DTE is supplying DTR.</p> <p>Check that the phone number you are calling is correct.</p>
<i>Modem won't dial</i>	<p>Ensure dial tone is present.</p> <p>If using DTR dial, check:</p> <ul style="list-style-type: none"> • Default dial option (AT*DA) • Phone number at stored location (presence of one) • DTR option (AT&D) <p>Check that the communications package's data rate is set to a rate that the modem's autobaud feature supports.</p>	<p>Check phone line and ensure it is properly connected to the modem's rear panel.</p> <p>Ensure default dial option is set to a location with a valid phone number.</p> <p>Ensure that DTR=108.1 (AT&D5) or Tail (AT&D4). Ensure the DTE is supplying DTR.</p>
<i>Unable to establish a connection</i>	<p>Check the disconnect code from the front panel or AT response.</p> <p>Check the modulation configuration:</p> <ul style="list-style-type: none"> • Mod (AT*MM) • Max Rate (AT*MX) • Min Rate (AT*MN) <p>Check EC/DC Mode (AT*SM)</p>	<p>Based on the disconnect reason, take the appropriate action.</p> <p>Ensure that Mod=C.Fast Auto or V32bis Auto.</p> <p>Ensure Mode=AutoRel (AT*SM3) on both the local and remote modems.</p>
<i>Software package displays on-line connection status before calling or answering is performed</i>	<p>Ensure DCD=Normal (AT&C1).</p>	<p>If DCD is <i>not</i> set to Normal, issue AT&C1 from the DTE or set DCD=Normal from the front panel.</p>
<i>A call is established but not maintained</i>	<p>Read the disconnect code.</p>	<p>Based on the disconnect reason, take the appropriate action.</p>

326X Series Modem Troubleshooting Guide (Continued)

Problem	Diagnosis/Test	Possible Solution
<i>Cannot hear connection through the speaker (stand-alone units)</i>	Check Speaker (ATM) option.	If the speaker is not on, turn it on.
	Check Volume (ATL) option.	Adjust volume.
DATA MODE		
<i>The modem connects, but cannot pass data</i>	Check that the modem is in data mode (“Data 9600”, for example, displays).	If the modem is not in data mode, establish a connection with the remote modem.
	Check that the TD LED is lit on modem's front panel (steady or flashing) indicating that the modem is receiving data from the DTE.	<ul style="list-style-type: none"> • Check DTE for EIA signal requirements. • Ensure the modem is correctly cabled to the DTE (with a straight-through cable for your electrical interface—V.35 or RS-232). • Check that the correct communications port is being used.
	Check the DTE rate of the local modem.	Ensure that the DTE rate matches the modem's terminal rate setting.
	Check the DTE's flow control method.	<ul style="list-style-type: none"> • Ensure that the DTE's flow control is the same as the modem's setting (for example, XON-XOFF, RTS/CTS). • If your communications software package's file transfer protocol is used, <i>and</i> the package supports RTS/CTS Flow control, set Flow=RTS/CTS (AT*FL3). If the package does not support RTS/CTS flow control, set Flow=Off (AT*FL0).
	If in normal mode, check for modem-to-modem flow control.	Turn modem flow control off.
	Verify line quality: <ul style="list-style-type: none"> • Run a remote digital loopback (RDL) or RDL with pattern test. • If you are still receiving errors, disconnect the modem from the line and perform a local analog loopback (LAL) or LAL with pattern test (with modem flow control off). 	<p>After running the RDL, if no errors occur, your line is good.</p> <p>If errors occur, perform a manual retrain, or retry the phone call.</p> <p>If the LAL or LAL with pattern test fails, contact Telenetics Customer Support or your local distributor.</p> <p>If the LAL or LAL with pattern test passes, you may have a line problem (contact your telephone company) <i>or</i> a problem with your application (check with your software vendor).</p>
<i>Premature disconnect</i>	Ensure that the remote modem supports error correction.	If the remote modem does not support error correction, set the modem to normal mode and retry the call.
	Check the disconnect reason from the modem's front panel.	Based upon the disconnect reason, take the appropriate action.

326X Series Modem Troubleshooting Guide (Continued)

Problem	Diagnosis/Test	Possible Solution
<i>Data is garbled or lost</i>	<p>Check the modem's flow control settings.</p> <p>Check that the modem's DTE rate, parity, and character length match the DTE's settings.</p> <p>If in normal mode, check line quality:</p> <ul style="list-style-type: none"> • Check CQMS parameters (signal quality and error probability). • Run a remote digital loopback (RDL) or RDL with pattern test. • If you are still receiving errors, disconnect the modem from the line and perform a local analog loopback (LAL) or LAL with pattern test (with modem flow control off). 	<ul style="list-style-type: none"> • Ensure that the DTE's flow control is the same as the modem setting (for example, XON-XOFF, RTS/CTS). • If your communications package's file transfer protocol is used, <i>and</i> the package supports RTS/CTS Flow control, set Flow=RTS/CTS (AT*FL3). If the package does not support RTS/CTS flow control, set Flow=Off (AT*FL0). <p>If they do not match, adjust as necessary.</p> <p>If no errors occur, the line is good.</p> <p>If errors occur, perform a manual retrain, or retry the phone call.</p> <p>If the LAL or LAL with pattern test fails, contact Telenetics Customer Support or your local distributor.</p> <p>If the LAL or LAL with pattern test passes, you may have a line problem (contact your telephone company) <i>or</i> a problem with your application (check with your software vendor).</p>
<i>Data stops passing</i>	<p>Modem could be in "flow off" condition (modem set for XON-XOFF and DTE set for hardware flow control).</p>	<ul style="list-style-type: none"> • Set the modem for hardware flow control. • Set Flow=Off (AT*FL0).
<i>The modem connects at a lower rate than the maximum (as set in the Max Rate (AT*MX) option)</i>	<p>Check CQMS parameters for line quality.</p> <p>Ensure that the remote modem supports the DCE rates you anticipate.</p>	<p>Line quality is not sufficient to support higher data rate. If line quality improves, the modem will increase its speed automatically.</p>
<i>Excessive modem retrains</i>	<p>Retry call.</p>	<p>Continuous retrains indicate a line problem. Contact your telephone company.</p>

326X Series Modem Troubleshooting Guide (Continued)

Problem	Diagnosis/Test	Possible Solution
CALL TERMINATION		
<i>Modem takes too long to disconnect</i>	Check to see if remote modem supports PSTN cleardown.	If remote modem doesn't support PSTN cleardown, try to change the setting of DCD Loss Disconnect (AT*CD) to a smaller number.
<i>Modem doesn't disconnect when DTR drops, or Modem doesn't disconnect when communications software package does</i>	Check modem's DTR option for correct setting.	<ul style="list-style-type: none"> • Set DTR to an option other than High. • Set DTR=Discon (AT&D2).
<i>Communications software package won't signal the modem to return to command state when escape sequence (+++) is issued</i>	<p>Check the delay between issuing the escape sequence (+++) and the ATH command.</p> <p>Check whether the modem is set for AT ACU.</p>	<p>Ensure the escape sequence (+++) complies with the modem's guard time requirements (refer to Line feed character:S-Register 4 for details).</p> <p>Set ACU Select=AT (ACU OPT's menu).</p>
FILE TRANSFER		
<i>Can't transfer all of a file or a file aborts in the middle of transfer</i>	<p>Check the modem's flow control settings.</p> <p>Check whether your communications package supports speed conversion.</p>	<p>Ensure that the DTE's flow control is the same as the modem's setting (for example XON-XOFF, RTS/CTS).</p> <p>If your communications software supports speed conversion, set modem's Speed Conver=On (AT*SC1).</p>
<i>It takes longer than expected to transfer a file</i>	Confirm which file transfer protocol you are using.	Use different protocol, for example, YMODEM, Y-GMODEM.
If operating the 326X-SDC modem in SDC mode, and you experience this type of problem...		
<i>BER tests do not work</i>	BER tests do not work in SDC mode because data is not framed.	
<i>Modem won't pass data</i>	<p>Ensure your DTE protocol is HDLC/SDLC-like data.</p> <p>Check for data format mismatch between modem and DTE (AT*DF).</p> <p>Check clocking requirements.</p>	<p>If your protocol is not HDLC/SDLC-like, use direct mode.</p> <p>Set data format option to match the DTE [NRZ (AT*DF0) or NRZI (AT*DF1)].</p> <p>Set modem for internal or external clock as required by your application.</p>

326X Series Modem Troubleshooting Guide (Continued)

Problem	Diagnosis/Test	Possible Solution
	Check whether modem is set for Flow =Tx Clk (AT*FL5).	If your DTE cannot handle Tx clock stopping, set Flow =Off (AT*FL0) <i>or</i> use CTS flow control.
	Check if TpDlyMin =Rx Clk (AT*TD1).	If your DTE equipment cannot handle Rx clock stopping, set TpDlyMin =Off (AT*TD0) <i>or</i> set TpDlyMin =RxD Dly (AT*TD2).
	If both modems are 326X-SDC, check to ensure option sets are the same in both modems.	If the option sets are not the same, select the same option sets in both modems using Select Options (ATZ) command.
	Check if one of your modems (local or remote) is a 326X-SDC unit.	If the local or remote modem is a 326X-SDC modem, set Fast Call =Off (AT*FC0) in it.
<i>Poor throughput performance</i>	Check your applications protocol: <ul style="list-style-type: none"> • If a window size of one is used (half duplex protocol)... • If using Novell IPX... 	Increase window size. Ensure burst mode is selected.
	Check whether TpDlyMin =Off (AT*TD0) <i>or</i> TpDlyMin =RxD Dly (AT*TD2).	If your DTE can handle Rx clock stopping, set TpDlyMin =Rx Clk.
	Check if modem is set for Flow =Off (AT*FL0).	If your DTE can handle Tx clock stopping, set Flow =Tx Clk (AT*FL5). If it does not support Tx clock stopping, use CTS.
	If performance is not satisfactory, experiment with frame and window sizes.	The optimum frame size for most applications is between 128 and 1024 bytes. The optimum window size for most applications is 7 to 4.
	If link utilization is low (as shown in the front panel throughput and link utilization status display)...	Increase the DTE rate.
<i>Poor throughput delay</i>	Check the setting of the flow control option.	Use Tx clock or CTS for flow control <i>and</i> Rx clock for throughput minimization delay.

326X Series Modem Troubleshooting Guide (Continued)

Problem	Diagnosis/Test	Possible Solution
<i>If operating the 326X Series Modem on a leased line, and you experience this type of problem...</i>		
<p>Modem won't connect</p> <p>NOTE: CQMS parameters are only valid once the modems are connected (in data mode)</p>	<p>Check leased line cable for conformance to 2- or 4-wire pinouts (U.S./Canada only).</p>	<ul style="list-style-type: none"> • For a 3261 2-wire leased line cable, pinouts should be Pin 1 (ring) and Pin 2 (tip) • For a 3261 4-wire leased line cable, pinouts should be: <ul style="list-style-type: none"> — Pins 1 (TX Ring) and 2 (TX Tip) — Pins 7 (RX Tip) and 8 (RX Ring) <p>For pinouts for your country and model, refer to Appendix C.</p> <ul style="list-style-type: none"> • Confirm the Tx and Rx connections for your leased line jack.
	<p>Ensure one modem is set for answer and one for originate.</p>	
	<p>Ensure modem is set to match line type (2- or 4-wire).</p>	
	<p>If you are still experiencing problems, run an LAL pattern test on both modems.</p>	<ul style="list-style-type: none"> • If errors are found on either end, contact Telenetics Customer Support or your local distributor. • If the LAL pattern test passes, you may have line problems; contact your telephone company.
	<p>Check the modulation configuration:</p> <ul style="list-style-type: none"> • Mode (AT*CA) • Max Rate (AT*MX) • Min Rate (AT*MN) 	<p>Ensure the local and remote modem's modulation modes are compatible with the maximum and minimum rate options.</p>
	<p>Check the leased line transmit level option in both the local and remote modems (LL TX Level, TELCO OPTS).</p>	<p>If this setting is adjustable in your country, adjust transmit level to approximately -15 dB.</p>

326X Series Modem Diagnostic Tests

The modem supports loopback, busy out, and retrain tests to assist you in isolating network problems. These tests analyze the telephone line and the local and remote modem's performance. These tests can be initiated from the modem's front panel, using AT commands from an attached PC or terminal, or from a network management system.

The following table shows the AT commands to initiate and terminate tests. The steps following the table describe how to initiate and terminate each test from the front panel. (Refer to your network management system documentation for instructions on initiating and terminating tests from the network management system.)

IMPORTANT: *The tests described in this section cannot be run simultaneously. Because each test interrupts data flow in a network, notify equipment users at both the local and remote sites before starting tests.*

For details on tests, refer to Chapter 4 of the *326X Series Modem Reference Guide*.

Test	Description	AT Command
Local Analog Loopback	Tests the local modem's transmit and receive circuits by looping local DTE data from the modem's transmitter to its receiver.	&T1
Local Analog Loopback Pattern	Tests the local modem's transmit and receive circuits with an internally generated test pattern.	&T8
Remote Digital Loopback	Using local DTE data, this test examines the transmit and receive circuits of the local and remote modems and the telephone line.	&T6
Remote Digital Loopback Pattern	Tests the transmit and receive circuits of the local and remote modems and the telephone line.	&T7
Data Mode Pattern	The modem uses internally generated test patterns to provide data and separately test the inbound and outbound halves of the transmission path.	Not applicable
Local Digital Loopback	Using the remote DTE data for the test, the telephone lines and the remote modem circuits are tested.	&T3
Busy Out	Allows the modem to appear busy to incoming calls.	H1
Retrain	Lets you manually retrain local and remote modems.	O1
(Terminate)	Terminates any test in progress.	&T0

Initiating and Terminating Tests from the Modem's Front Panel

To initiate a test from the modem's front panel:

- 1) Press ▼ until you reach the TEST OPTS category.
- 2) Press ► until you reach **Test=End Test**.
- 3) Press ▼ until **Test=LAL** (for example)
- 4) Press ◎ to start the test.

To terminate a test from the modem's front panel:

- 1) Press ▼ until **Test=End Test**.
- 2) Press ◎ to stop the test.

Synchronous Data Compression (SDC) Testing

When performing diagnostic tests in SDC mode, note the following:

- All tests are supported
- When initiating the following “online” tests:
 - Remote digital loopback
 - Remote digital loopback pattern
 - Data mode pattern
 - Local digital loopback

during SDC connection, the modem falls back to Direct mode (**Mode=Direct**, **AT*SM**) to run the test. If the modem is set for internal timing (**Clock=Internal**, **AT&X**) the DTE clock is changed to match the DCE rate. If the modem is set for external timing (**Clock=External**, **AT&X**), the clock rate provided may not match the DCE rate and the test will not function. (Set **Clock=Internal** temporarily to complete testing, and then reset to External.)

- To test the synchronous data path's integrity while running loopback tests, set the modem for one of the asynchronous buffered modes (**Mode=Normal**, **Reliable**, **Auto Reliable**, or **Speed Auto Reliable**).

Appendix A

Configuration Quick Reference

Contents

Configuration Quick-Reference—Menu Trees	A-2
For More Detail	A-2
Audience and Assumptions	A-2
Performing Numeric Entry	A-37
S-Register/AT Command Cross-Reference	A-38
Dial Modifiers for Special Dialing Requirements	A-39
Result Codes	A-41
Configuring the Modem's Dual In-line Package (DIP) Switches	A-44

Configuration Quick-Reference—Menu Trees

This appendix contains information useful for configuring and operating the modem:

- **Configuration options** and functions:
 - *Table A-1 lists AT commands.* Commands are cross-referenced to front panel options. Parameters whose options are restricted due to country requirements are shaded gray.
 - *Table A-2 lists configuration options that do not have AT equivalents.* These options are organized by the main menu in which they appear.
- The **menu structure (Figures A-1 to A-4)**: front panel options, option settings, and AT, AT&, AT* command equivalents, and default settings. (The *Reference Card* shows the menu tree as well.)
- **Numeric entry** information: how to use the front panel control keys to change numeric values of configuration settings.
- **S-Registers**, cross-referenced to AT Commands and front panel options.
- **Dial modifiers**
- **Result codes**: numeric (short form) and word (long form)
- Instructions for configuring **Dual In-line Package (DIP) switches**, which let you override configuration settings normally selected through AT commands or the front panel.

For More Detail

For more information on configuration, order the *326X Series Modem Reference Guide* by contacting your Telenetics sales representative or local distributor.

Audience and Assumptions

This chapter assumes you understand AT command syntax and use. (To review, refer to Chapter 5, Using the AT Automatic Calling Interface.)

This chapter assumes you understand how to use the front panel to navigate the configuration menus, *and* how to alter configuration options. (To review, refer to Chapter 3, Getting Started.)

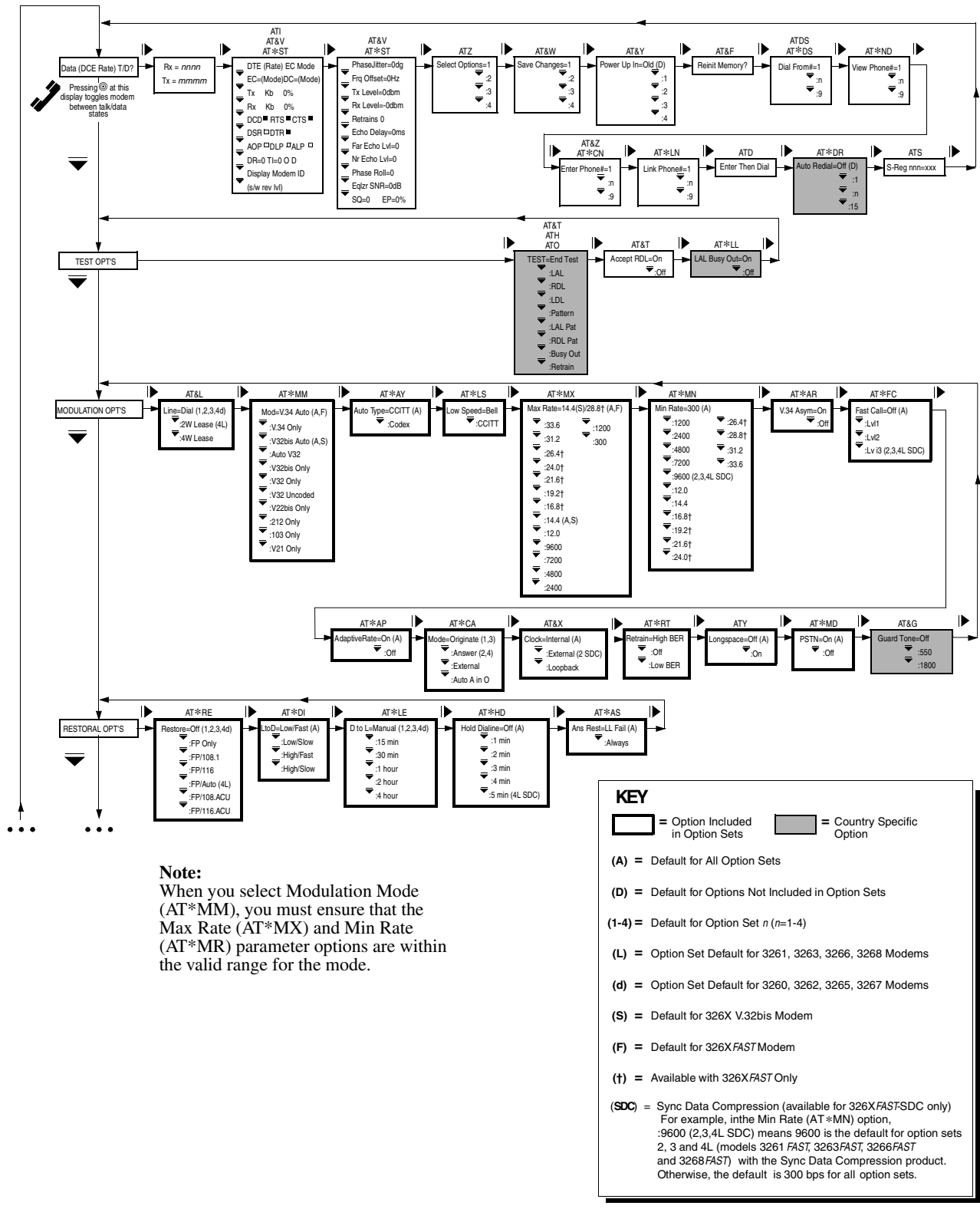
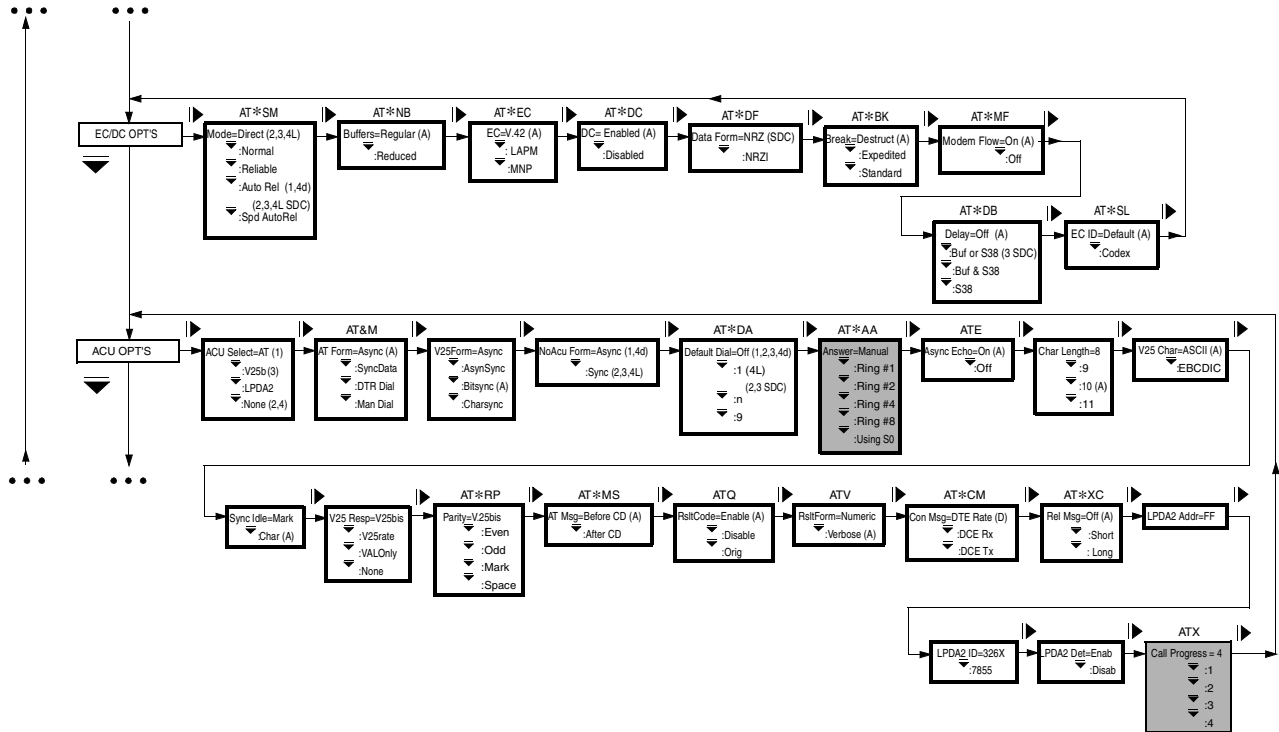

Figure A-1. The 326X Series Modem Menu Structure - Part 1 of 4



KEY

= Option Included in Option Sets = Country Specific Option

(A) = Default for All Option Sets

(D) = Default for Options Not Included in Option Sets

(1-4) = Default for Option Set n ($n=1-4$)

(L) = Option Set Default for 3261, 3263, 3266, 3268 Modems

(d) = Option Set Default for 3260, 3262, 3265, 3267 Modems

(S) = Default for 326X V.32bis Modem

(F) = Default for 326X FAST Modem

(†) = Available with 326X FAST Only

(SDC) = Sync Data Compression (available for 326X FASTSDC only)
 For example, in the Min Rate (AT*MN) option,
 :9600 (2,3,4L SDC) means 9600 is the default for option sets
 2, 3 and 4L (models 3261FAST, 3263FAST, 3266FAST
 and 3268FAST) with the Sync Data Compression product.
 Otherwise, the default is 300 bps for all option sets.

Figure A-2. The 326X Series Modem Menu Structure - Part 2 of 4

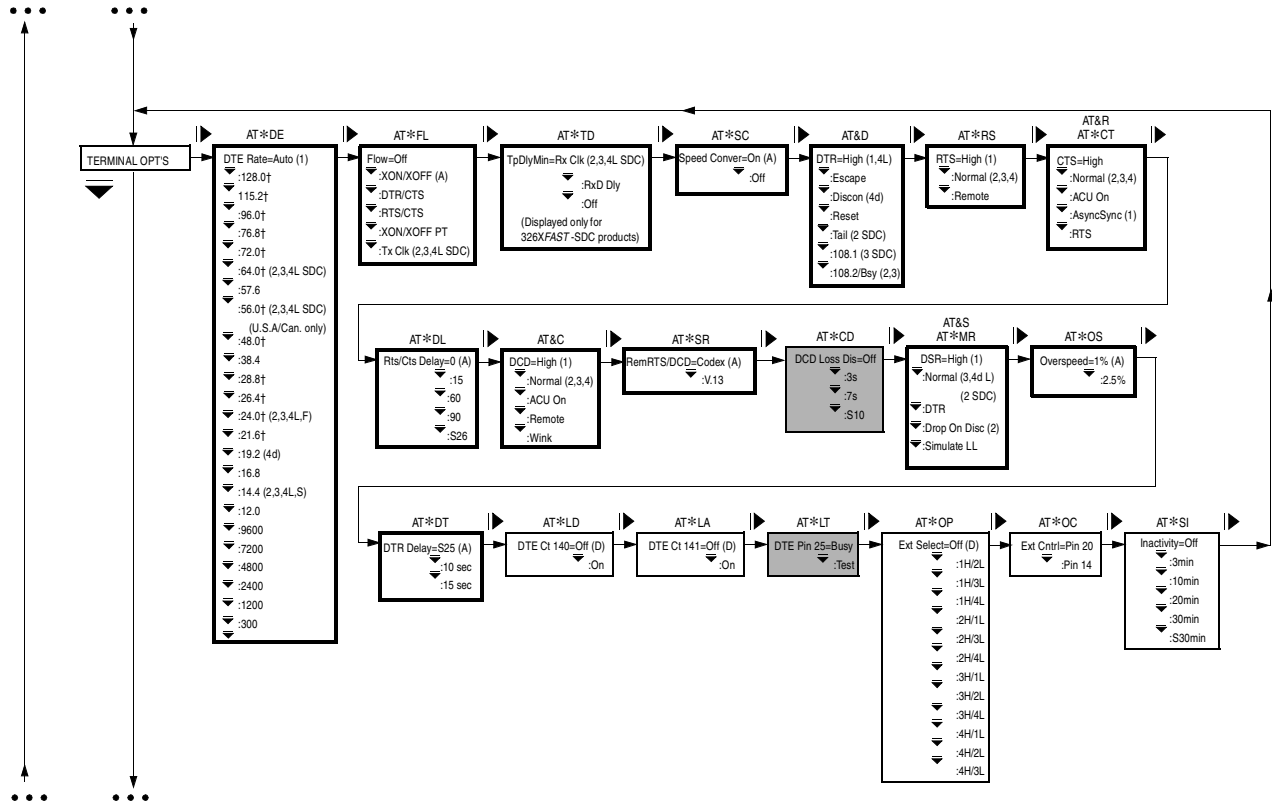

Figure A-3. The 326X Series Modem Menu Structure - Part 3 of 4

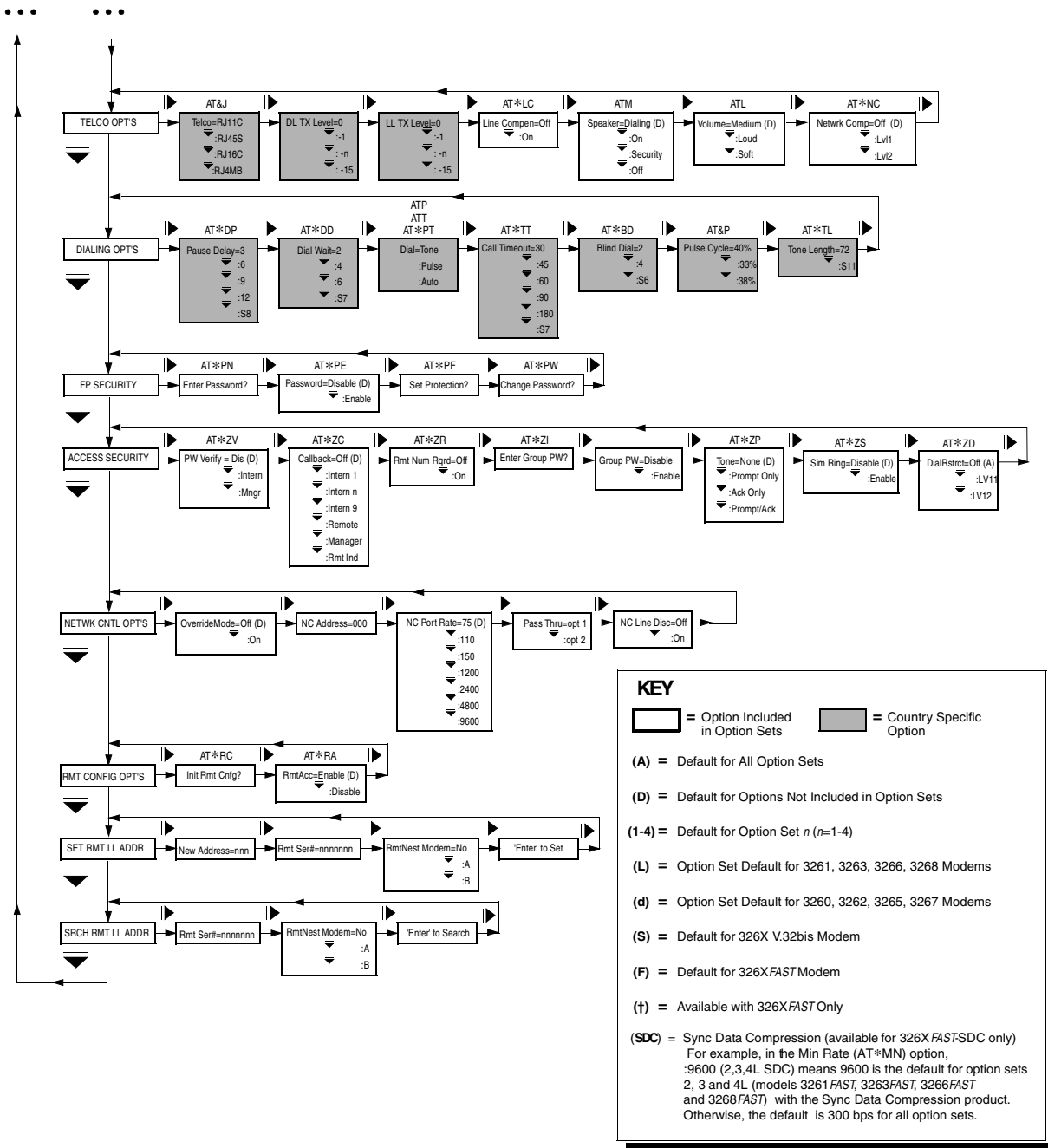

Figure A-4. The 326X Series Modem Menu Structure - Part 4 of 4

Table A-1.
AT Commands, Cross-Referenced to Front Panel Options

AT Command	Parameter & Option	Description
+++	—	<i>Escape Data Mode</i> Enter command mode (does not require AT prefix or <CR>. The character is determined by the content of S-Register 2.
A/	—	<i>Re-Execute Last Command</i> Re-executes the last AT command string issued to the modem, including redialing a telephone number. (Does not require AT prefix or <CR>.) The modem has a redial security feature. See the AT*ZD command for details.
AT=x	—	<i>Change S-Register Value (x=new value)</i> Lets you change the setting of the S-Register that was last accessed with an S-Register command.
AT?	—	<i>Display S-Register Value</i> Displays the contents of the last S-Register accessed.
AT	—	<i>Attention Code</i> Precedes all commands except (+++) and A/.
ATA	—	<i>Manual Answer</i> Causes the modem to answer a call regardless of the ring count.
ATDn	Enter Then Dial	<i>Dialing an Unstored Telephone Number (n=phone number)</i> Lets you dial a telephone number of up to 50 characters without storing it in the modem's telephone book. To dial a number using AT commands, enter ATD, followed by the telephone number and a carriage return. Example: ATD5551234<CR>
ATDSn, ATDS=n, or AT*DSn, AT*DS=n	Dial From Stored #=n	<i>Dialing a Stored Telephone number (n=1-9)</i> Dial telephone number stored in address n. Before using this option, enter a telephone number into the modem address book. See AT&Z, AT*CN to learn how to enter telephone numbers. If you enter ATDS or ATDS= without a number following, the modem dials the number in Address 1. To dial a number using AT Commands, enter ATDS, ATDS=, or AT *DS followed by the telephone book address number and a carriage return. For example: ATDS2<CR> NOTE: You can include dial modifiers to instruct the modem how and when to dial a call. The dial modifiers used with the AT ACU are described in Table A-4.
	Async Echo	<i>Asynchronous Echo</i>
ATE0	=Off	The modem does not echo asynchronous commands to the DTE.
ATE1	=On	The modem echoes asynchronous commands to the DTE.
	TEST	<i>Busy Out Test</i>
ATH0	=End Test	If busy out is enabled, ATH0 disconnects the busy out condition. In "escape mode" (modem has transitioned to command state from data state), ATH0 disconnects the modem.
ATH1	=Busy Out	Makes the modem appear busy to incoming calls.

Gray shading indicates country-specific options. See Appendix C for your country's options.

Table A-1.
AT Commands, Cross-Referenced to Front Panel Options (Continued)

AT Command	Parameter & Option	Description
ATIn	—	<i>Display Software Information (n= 0, 1, 2, 9)</i> 0=displays 960 1=displays 000 2=displays OK 9=displays reason for last disconnect These messages are sent with OK, when AT command processing is complete.
	Volume	<i>Speaker Volume</i>
ATL0/ATL1	=Soft	The speaker volume is set to soft.
ATL2	=Medium	The speaker volume is set to medium.
ATL3	=Loud	The speaker volume is set to loud.
	Speaker	<i>Speaker Control</i>
ATM0	=Off	The speaker is always off.
ATM1	=Dialing	The speaker is on when dialing and training, and off when the modem enters data mode.
ATM2	=On	The speaker is always on.
ATM3	=Security	The speaker is on when dialing is complete and off when the modem enters data mode.
		<i>Retrain</i>
ATO0	—	The modem leaves command mode and returns online (to data mode).
ATO1	TEST=Retrain	The modem leaves command mode, returns online, and initiates a retrain with the remote modem.
	Dial	<i>Dial Type</i>
ATP	=Pulse	The modem uses pulse dialing unless otherwise specified by the T or P modifiers.
	RsltCode	<i>Result Codes</i>
ATQ0	=Enable	Result codes are displayed at the DTE.
ATQ1	=Disable	Result codes are not displayed at the DTE.
ATQ2	=Orig	Result codes are output to the DTE only when operating as an originate modem.
	S-Regxxx	<i>S-Register</i>
ATS	= <i>nmn</i>	Lets you view and set S-Registers (where xxx equals the S-Register to change and <i>nmn</i> equals the value of the register). The value must be within the specified range (see Chapter 5 for a full description of S-Registers).
	Dial	<i>Dial Type</i>
ATT	=Tone	The modem uses tone dialing unless otherwise specified by the T or P modifiers.
	RsltForm	<i>Result Code Format</i>
ATV0	=Numeric	Result codes are sent to your DTE as numbers (short form).
ATV1	=Verbose	Result codes are sent to your DTE as full words (long form).
	Call Progress	<i>Call Progress</i>
		Determines whether the modem waits for call progress signals or blind dials when establishing calls.
ATX0	=0	The modem uses only NO CARRIER and CONNECT result codes.
ATX1	=1	The modem uses only NO CARRIER, CONNECT, and CONNECT <Rate> result codes.
<i>Gray shading indicates country-specific options. See Appendix C for your country's options.</i>		

Table A-1.
AT Commands, Cross-Referenced to Front Panel Options (Continued)

AT Command	Parameter & Option	Description
ATX2	=2	The modem waits for dial tone and uses only NO CARRIER, CONNECT, CONNECT <Rate> and NO DIALTONE result codes.
ATX3	=3	The modem detects busy signal and uses NO CARRIER, CONNECT, CONNECT <Rate>, and BUSY result codes.
ATX4	=4	The modem waits for dial tone and detects busy signal. Only NO CARRIER, CONNECT, CONNECT <Rate>, BUSY, and NO DIAL TONE result codes are used.
Longspace		<i>Longspace Disconnect</i>
ATY0	=Off	The modem does not disconnect when it receives space longer than 1.6 seconds. When terminating a call, the modem does not send continuous space for 4 seconds.
ATY1	=On	The modem disconnects when it receives space longer than 1.6 seconds. When terminating a call, the modem sends continuous space for 4 seconds.
Select Options		<i>Selecting an Option Set</i>
		The new option set takes effect immediately.
ATZ0/ATZ1	=1	The modem uses Option Set 1.
ATZ2	=2	The modem uses Option Set 2.
ATZ3	=3	The modem uses Option Set 3.
ATZ4	=4	The modem uses Option Set 4. NOTE: The modem disconnects from the line when ATZ is entered. Any test in progress is terminated. Since any AT command that follows ATZ is ignored by the modem, ensure that ATZ is the last command entered in a command string. Use the AT&Y command to select the option set in which the modem powers up.
DCD		<i>DCD Control</i>
		Determines how the modem sets DCD signals. The modem signals the DTE with DCD on EIA/TIA 232-D Pin 8 (V.24 Circuit 109).
AT&C0	=High	DCD is always on.
AT&C1	=Normal	DCD is off during dialing and while the modem is training with the remote modem. DCD is on in data mode. It is off when the modem is disconnected from the telephone line.
AT&C2	=ACU On	DCD is on when the modem is disconnected so that terminals requiring this signal can use the ACU. During dialing, DCD goes off until both modems train and are ready to pass data. DCD is on in data mode. DCD drops on a disconnect momentarily.
AT&C3	=Remote	This setting applies to simulated half-duplex applications and works only if the remote modem also supports RTS/DCD signaling. When the remote DTE turns RTS on, DCD is forced on at the local modem. The local modem can receive data only during this period. Once the remote DTE drops RTS, DCD at the local modem follows. The Rem RTS/DCD option lets you choose the type of RTS/DCD signaling.
AT&C4	=Wink	DCD is always on; however, it drops after disconnect and remains low momentarily.
DTR		<i>DTR Control</i>
		This command determines how the modem interprets the DTR signal. The local DTE uses DTR (Pin 20) to signal the modem.
AT&D0	=High	The modem ignores DTR from the DTE. The modem reads DTR as always high. Choose this option for DTR/CTS flow control with error correction, or if the DTE does not provide DTR signal.
AT&D1	=Escape	When ACU Select=AT and AT Form=Async (AT&M), the modem enters the AT Escape mode (+++) when DTR goes off while the modem is in data or test mode.
<i>Gray shading indicates country-specific options. See Appendix C for your country's options.</i>		

Table A-1.
AT Commands, Cross-Referenced to Front Panel Options (Continued)

AT Command	Parameter & Option	Description
AT&D2	=Discon	The modem hangs up and enters command mode when an on-to-off DTR transition is detected, while the modem is in data, test, or escape mode. If DTR is low, the modem does not auto answer.
AT&D3	=Reset	The modem hangs up (if connected) and loads the specified option set when an on-to-off DTR transition occurs. If DTR is low, the modem auto answers.
AT&D4	=Tail	This setting is similar to 108.1 except that the modem auto answers an incoming call even if DTR is off. When DTR transitions from off to on, the modem connects to the telephone line and dials (if the Default Dial option is enabled).
AT&D5	=108.1	The DTR signal emulates the function of the Talk/Data (Ⓢ at the Home position) key on the modem's front panel. An off-to-on DTR transition instructs the modem to connect to the telephone line. If the modem detects an incoming ring, it answers the call. If the modem does not detect an incoming call, the modem dials the number specified by the Default Dial option. An on-to-off DTR transition disconnects the modem from the telephone line.
AT&D6	=108.2	When the modem is disconnected from the telephone line, and DTR is turned on by the DTE, the modem responds to all AT commands. When the DTE turns DTR off, the modem does not respond to dialing and answering AT commands, but responds to all other AT commands. The DTR signal must remain on throughout the connection. An on-to-off DTR transition disconnects the modem from the telephone line. If DTE is low, the modem does not auto answer.
AT&D7	=108.2/Bsy	<p>When the modem is disconnected from the telephone line, and the DTE asserts DTR, the modem responds to all AT commands. The DTR signal must remain asserted throughout the connection.</p> <p>When the DTE de-asserts DTR:</p> <ul style="list-style-type: none"> • The modem disconnects from the telephone line. If DTR is de-asserted, the modem activates Busyout status. • The modem does not respond to dialing and answering commands, but responds to all other commands.
<i>Reinitialize Memory</i>		
AT&F	Reinit Memory?	<p>Resets the modem to factory default settings. The four factory default option sets are restored to their original settings, and all stored telephone numbers are deleted.</p> <p>Enter: AT&F<CR>. The modem displays 326x Initial and the terminal displays OK.</p> <p>The factory-programmed option sets are now in place.</p>
<i>Guard Tone</i>		
Guard Tone		<i>Guard Tone</i>
This command determines what type of guard tone the modem uses in V.22bis operation. The proper guard tone (AT&G) option setting is required by your PTT.		
AT&G0	=Off	The modem does not use a guard tone.
AT&G1	=550	The modem uses a guard tone of 550 Hz.
AT&G2	=1800	The modem uses a guard tone of 1800 Hz.
<i>Display Modem ID</i>		
AT&I0	Modem ID# 1	Software part number.
AT&I1	Modem ID# 1	Factory product code.
AT&I2	Modem ID# 1	Country code

Gray shading indicates country-specific options. See Appendix C for your country's options.

Table A-1.
AT Commands, Cross-Referenced to Front Panel Options (Continued)

AT Command	Parameter & Option	Description
AT&I3	Modem ID# 1	Product code
AT&I4	Modem ID# 1	Network control address (optional)
AT&I5	Modem ID# 1	Device serial number
Telco <i>Dial Line Jack Type</i>		
AT&J0/ AT&J1	=RJ11C	This 6-pin modular jack type is the most common permissive data mode (voice) jack arrangement found in the home or office and operates on a single-line bridged tip-and-ring voice or low-speed data application service.
AT&J2	=RJ45S	This 8-pin modular jack type is the most common programmable jack arrangement and permits the use of an exclusion key telephone. This jack also operates on a single-line bridged tip-and-ring voice or low-speed data application service. NOTE: When installing the modem in a PBX environment, the interface to the PBX should be a voice grade jack (RJ11). Although an RJ11 jack is installed, Telenetics recommends that Telco=RJ45S. This optimizes modem performance the when operating at high data rates over a PBX. In a normal Telco-supplied loop situation, the telco options setting should match the jack type installed.
AT&J3	=RJ16CS	This 6-pin modular jack type is a special permissive data mode jack arrangement that allows use of an exclusion key telephone.
AT&J4	=RJ4MB	This 8-pin modular programmable data mode jack arrangement supports Make Busy operation. Using this jack type, you can make the modem appear to be off-hook to the central telephone office. Note: In modems in the U. S. A. and Canada, the Make Busy function operates only in nest card modems. (Make Busy settings display in standalone modems, but are not active.)
Line <i>Line Type</i>		
AT&L0	=Dial	The modem communicates over dial lines in dial applications only.
AT&L1	=2W Lease	The modem communicates over a 2-wire leased line. The ACUs (AT and V.25bis) are not functional when the modem is connected to a leased line.
AT&L2	=4W Lease	The modem communicates over a 4-wire leased line. The ACUs (AT and V.25bis) are not functional when the modem is connected to a leased line.
AT Form <i>AT Data Format</i>		
Determines the format of the data when ACU Select is set to AT.		
AT&M0	=Async	The modem communicates asynchronously in command and data mode.
AT&M1	=Sync Data	The modem communicates asynchronously when in command mode (disconnected from the dial line), and synchronously when in data mode.
AT&M2	=DTR Dial	When an off-to-on DTR transition is detected, the modem dials the number stored in the memory location designated by the Default Dial option. Once connected, the modems transmit data synchronously. If DTR transitions from on-to-off, the modem hangs up and returns to the asynchronous command mode.
AT&M3	=Man Dial	DTR signals toggle between talk and data mode. With DTR off, numbers can be dialed from a telephone. Once an answer tone is heard, the telephone is hung up, and DTR is raised; the modems connect and send data synchronously.
Pulse Cycle <i>Pulse Cycle</i>		
AT&P0	=40%	The make/break ratio is 40:60.
AT&P1	=33%	The make/break ratio is 33.5:66.5.
AT&P2	=38%	The make/break ratio is 38.5:61.5.
<i>Gray shading indicates country-specific options. See Appendix C for your country's options.</i>		

Table A-1.
AT Commands, Cross-Referenced to Front Panel Options (Continued)

AT Command	Parameter & Option	Description
	CTS	<i>CTS Control</i>
		Determines how the modem sets the CTS signal. The modem signals the DTE with CTS on EIA/TIA 232-D Pin 5 (V.24 Circuit 106). The CTS Signal discussed here is the state of the CTS signal after the setting of the modem's RTS option has been followed. For CTS to follow the RTS signal from the DTE, set the modem RTS= Normal.
AT&R0/ AT*CT3	=AsyncSync	CTS is on in asynchronous mode. CTS is off in synchronous, ACU mode. If the data transfer mode is synchronous, CTS is off during training/retraining and follows RTS in data mode. When CTS follows RTS in data mode, the setting of the RTS/CTS Delay option applies (if Mode=Direct).
AT&R1/ AT*CT0	CTS=High	CTS remains high at all times. Use this option with RTS/CTS or DTR/CTS Flow control.
	DSR	<i>DSR Control</i>
		Determines how the modem sets the DSR signal. The modem signals the DTE with DSR on EIA/TIA 232-D Pin 6 (V.24 Circuit 107).
AT&S0	=High	DSR is always on.
AT&S1	=Normal	DSR is controlled by the modem.
	TEST	<i>Test</i>
AT&T0	=End Test	Ends the test currently in progress for each test listed below (except retrain).
AT&T1	=LAL	Initiates a local analog loopback test.
AT&T3	=LDL	Initiates a local digital loopback test.
	Accept RDL	<i>Accept RDL</i>
AT&T4	=On	The local modem can be put into a remote digital loopback test.
AT&T5	=Off	The local modem cannot be put into a remote digital loopback test.
AT&T6	TEST=RDL	Initiates a remote digital loopback test.
AT&T7	TEST=RDL Pat	Initiates a remote digital loopback pattern test.
AT&T8	TEST=LAL Pat	Initiates a local analog loopback pattern test.
	Status	<i>Modem Status Display</i>
AT&V0	Long Form Status	Lets you view modem status information, on the control terminal, in long form. The display shows operating status, DTE/DCE rate/status, asymmetric rates status, connect message status, the data form, throughput-delay minimization status, error correction status, data compression status, EIA/TIA signal status, disconnect reasons, the software revision level, and CQMS parameters. The long form also shows front panel options and corresponding AT commands.
AT&V1	Short Form Status	Lets you view modem status information, on the control terminal, in short form. This displays a summary of AT command settings and S-register values.
	Save Changes	<i>Save Changes</i>
		When using AT Commands or front panel options to alter modem settings, if you do not save the changes, the modem does not enter them into memory. After you have selected the option set for your application (using the ATZn Command), and modified configuration settings, enter: AT&Wn where n=(Option Set) 1 through 4. The modem displays Saving Options, then Save Completed! signifying that the option set has been saved in nonvolatile memory.
AT&W0/ AT&W1	=1	Save changes to Option Set 1.
Gray shading indicates country-specific options. See Appendix C for your country's options.		

Table A-1.
AT Commands, Cross-Referenced to Front Panel Options (Continued)

AT Command	Parameter & Option	Description
AT&W2	=2	Save changes to Option Set 2.
AT&W3	=3	Save changes to Option Set 3.
AT&W4	=4	Save changes to Option Set 4.
	Clock	<i>Clock</i>
		Sets modem timing and applies to synchronous applications only. For most dial applications, use internal timing.
AT&X0	=Internal	The modem uses internal timing; timing signals are passed on EIA/TIA 232-D Pin 15(V.24 circuit 114). Internal timing is used for most applications.
AT&X1	=External	The modem uses external timing; timing signals are passed on EIA/TIA 232-D Pin 24(V.24 circuit 113). Internal timing is used for most applications.
AT&X2	=Loopback	The modem uses loopback timing; timing signals are passed on EIA/TIA 232-D Pin 17 (V.24 circuit 115). NOTE: This selection is not available in SDC mode. If you select loopback with SDC mode enabled, the modem uses internal timing instead.
	Power Up In	<i>Power Up In Option Set</i>
AT&Y0	=Old	When you turn on the modem, it automatically uses the last saved option set.
AT&Y1	=1	When you turn on the modem, it automatically uses Option Set 1.
AT&Y2	=2	When you turn on the modem, it automatically uses Option Set 2.
AT&Y3	=3	When you turn on the modem, it automatically uses Option Set 3.
AT&Y4	=4	When you turn on the modem, it automatically uses Option Set 4.
	Enter Phone #	<i>Enter Telephone Numbers (where n=1-9)</i>
AT&Zn	=1-9	Lets you store up to nine telephone numbers in the modem's "address book" of up to 50 characters each. To enter a number into the address book: enter the AT&Z or AT*CN command, the telephone book address (1-9), a comma, and the telephone number to store. For example, to store the number 1-222-555-444 in memory location 3, enter: AT*CN3,12225554444<CR> If you enter AT&Z or AT*CN without specifying a memory location, the modem stores the number in address 1. If no telephone number follows AT&Z or AT*CN, the specified memory location's telephone number is deleted. NOTE: When dialing telephone numbers, you can include dial modifiers to instruct the modem how and when to dial a call. Refer to Table A-4.
	Answer	<i>Answer</i>
AT*AA0	=Manual	An incoming call must be answered manually.
AT*AA1	Answer=Ring # 1	The modem automatically answers an incoming call after the first ring.
AT*AA2	=Ring # 2	The modem automatically answers an incoming call after the second ring.
AT*AA3	=Ring # 4	The modem automatically answers an incoming call after the fourth ring.
AT*AA4	=Ring # 8	The modem automatically answers an incoming call after the eighth ring.
AT*AA5	=Using S0	The modem automatically answers an incoming call according to the setting of S-Register S0.
	Adaptive Rate	<i>Adaptive Rate Feature</i>
AT*AP0	=Off	The modem does not use the adaptive rate feature.
<i>Gray shading indicates country-specific options. See Appendix C for your country's options.</i>		

Table A-1.
AT Commands, Cross-Referenced to Front Panel Options (Continued)

AT Command	Parameter & Option	Description
AT*AP1	=On	<p>The modem monitors telephone line signal quality and negotiates the highest possible rate for a modem's modulation mode. You must enable Retrain (AT*RT) to use the Adaptive Rate. Close rear panel switch 1 down so that the modem can inform the terminal of rate changes See "Configuring the Modem's Dual In-line Package (DIP) Switches" section in this appendix for information.</p> <p><i>Adaptive Rate Operation in V.34 Modulation Mode</i></p> <p>In the V.34 modulation mode, with Adaptive Rate=On (MODULATION OPTS Menu, or AT*AP1), the modem selects the optimum data rate on the first connection. The modem then monitors line conditions, and if conditions deteriorate (i.e., poor signal quality), the modems retrain and determine the rate that the line can support, within the range specified in Max Rate (AT*MX) and Min Rate (AT*MN). Under poor line conditions, the modem may fall back by more than one rate.</p> <p>For example, at a data rate of 28.8 kbps, under poor line conditions, the modem may retrain to 19.2 kbps instead of 21.6 kbps. ARS adjustment is based on the High/Low BER setting of the AT*RT (Retrain) option.</p> <p>NOTES:</p> <ol style="list-style-type: none"> 1) The AT*RT (Retrain) command <i>must</i> be enabled (set to Low BER or High BER) if you use the adaptive rate setting. 2) The modem does not fall forward in V.34 modulation mode with ARS enabled.
<p><i>Line Probing Feature Operation in V.34 Mode</i></p> <p>The modem uses a line probing feature during the initial training sequence. Line probing selects the maximum data rate that the line can support, as well as the optimal baud rate and carrier frequency. Due to this, in the V.34 modulation modes (V.34 Auto and V.34 Only), the modem may require a longer training sequence.</p> <p>NOTE: For a summary of the supported data rates, baud rates and carrier frequencies, refer to the "V.34 Modulation Mode Characteristics" section in Chapter 1.</p>		
<p><i>If You Operate the Modem in V.34 Mode with ARS Disabled...</i></p> <p>If you operate the modem in the V.34 modulation mode with the ARS option disabled (AT*AP0), the modem selects the optimum data rate that can be supported (as determined by the line probing feature described above) on the first connection.</p> <p>With ARS disabled, the modem does not automatically fall back when line conditions deteriorate.</p> <p>NOTE: When external timing is selected, configure the modem so that the minimum rate is equal to the maximum rate. This will force the modems to come up at a specific data rate only.</p>		
<p>Asym Rate <i>V.34 Asymmetric Rate</i></p> <p>Controls whether the modem permits different transmit and receive DCE rates.</p>		
AT*AR0	=Off	Asymmetric Rate
AT*AR1	=On	
<p>Ans Rest <i>Answer In Restoral</i></p> <p>Controls whether the modem answers a call on the dial line while connected to the leased line.</p>		
AT*AS0	=LL Fail	When connected on a leased line, the modem answers an incoming call only if the leased line fails.
<p>Gray shading indicates country-specific options. See Appendix C for your country's options.</p>		

Table A-1.
AT Commands, Cross-Referenced to Front Panel Options (Continued)

AT Command	Parameter & Option	Description
AT*AS1	=Always	A dial call is always answered. As soon as the dial call is answered, the leased line connection is dropped (with auto-answering, the leased line is dropped after the correct number of rings). If training on the dial line fails, the modem returns to the leased line.
Auto Type <i>Auto Type</i>		
AT*AY0	=CCITT	During answer-back tone, the modem attempts to negotiate a connection in the V.32 modulation mode. As soon as answer-back tone ends, if a V.32 tone has not been detected during ABT, the modem attempts to negotiate a connection in the V.22bis modulation mode.
AT*AY1	=Codex	During answer-back tone, the modem attempts to negotiate a connection in the V.32 modulation mode. After sending answer-back tone, the modem continues to attempt to negotiate a connection in the V.32 modulation mode. If unsuccessful, the modem tries to negotiate a connection in the V.22bis modulation mode.
Blind Dial <i>Blind Dial</i>		
Determines the time the modem waits before dialing; once time has expired, the modem dials without waiting for a dial tone.		
AT*BD0	=2	The modem waits 2 seconds before dialing.
AT*BD1	=4	The modem waits 4 seconds before dialing.
AT*BD2	=S6	The modem waits the amount of time specified by S-Register 6 before dialing.
Break <i>Break Handling</i>		
Controls how the modem handles the break signal in reliable and auto-reliable data modes. Break signals are sent to the DTE for the duration specified in S-Register 97.		
AT*BK0	=Destruct	The modem uses destructive and expedited break handling. It passes the break to the remote site immediately and deletes all data from its buffers. NOTE: Destructive breaks reinitialize data compression tables for MNP-5 and V.42bis.
AT*BK1	=Expedited	The modem uses nondestructive and expedited break handling. It passes the break to the remote site immediately without deleting data from its buffers.
AT*BK2	=Standard	The modem uses standard break handling. It passes the break to the remote site in sequence with any transmit data from its buffers.
Mode <i>Answer/Originate Mode</i>		
AT*CA0	=Orig	The modem operates as an originating modem in a manual answer/dial application.
AT*CA1	=Answer	The modem operates as an answer modem in a manual answer/dial application.
AT*CA2	=External	The signal from the DTE on EIA/TIA 232-D Pin 11 determines whether the modem is in answer or originate mode. If the signal is off, the modem is in originate mode; if the signal is on, the modem is in answer mode
AT*CA3	=Auto A in O	The modem configures itself as an originating modem after auto-answering a call. In leased-line operation, the modem functions as if it is set to originate calls. NOTE: The functions provided by this setting only apply when the modem auto-answers.
DCD Loss Dis <i>DCD Loss Disconnect</i>		
AT*CD0	=Off	The modem will not disconnect due to loss of carrier.
AT*CD1	=3 s	The modem hangs up if it loses carrier for 3 seconds.
AT*CD2	=7 s	The modem hangs up if it loses carrier for 7 seconds.
AT*CD3	=S10	The modem checks the value stored in S-Register 10 to determine when it disconnects due to loss of carrier. See the “S-Registers” section in Chapter 5 for more information.

Gray shading indicates country-specific options. See Appendix C for your country's options.

Table A-1.
AT Commands, Cross-Referenced to Front Panel Options (Continued)

AT Command	Parameter & Option	Description
	Con Msg	<i>Connect Message</i>
AT*CM0	=DTE Rate	Selecting DTE Rate results in the current DTE rate being displayed on your terminal after the connect message.
AT*CM1	=DCE Rate	Selecting DCE Rate results in the current DCE rate being displayed on your terminal after the connect message.
AT*CN1 – 9,(phone no.)	Enter Phone # =1–9	See the AT&Z command description.
AT*CT0/ AT&R1	CTS=High	CTS is always high. Use this setting if you plan to use RTS/CTS or DTR/CTS Flow control.
AT*CT1	=Normal	The modem controls CTS as in normal handshaking. In V.25bis ACU operation, CTS follows DTR in command state; CTS is off in training/retraining and follows RTS in data mode. For AT ACU operation, CTS follows RTS in command state; CTS is off in training/retraining and follows RTS in data mode. If an ACU is not selected, CTS is low.
AT*CT2	=ACU On	CTS is on in ACU mode, goes off during training/retraining, and follows RTS in data mode.
AT*CT3/ AT&R0	=AsyncSync	CTS is on in asynchronous mode, and off in synchronous, ACU mode. In synchronous data transfer mode, CTS is off in training/retraining and follows RTS in data mode. When CTS follows RTS in data mode, the setting of the RTS/CTS Delay option applies (if Mode=Direct).
AT*CT4	=RTS	CTS follows RTS. Use this setting if your application requires that CTS immediately follow RTS. If one of these flow control methods is used: Flow=RTS/CTS or Flow=DTR/CTS, then CTS <i>does not</i> follow RTS in a flow-off condition. When CTS=RTS, the RTS/CTS Delay (AT*DL) option is not available.
	Default Dial	<i>Default Dialing</i>
AT*DA0	=Off	The default dial feature is disabled.
AT*DA1 – 9	=1 – 9	The modem direct dials the telephone number stored in the memory address selected (memory addresses 1 – 9) when one of the following conditions occurs: <ul style="list-style-type: none"> •DTR=108.1 or Tail, and the DTE turns the DTR signal from off to on. •DTR=108.2, Esc, Discon, Reset, or High; the DTR signal is on; and either the front panel Talk/Data key (Ⓢ at the Home position) is pressed, or control of the dial is switched to the modem with an exclusion key telephone. •ACU Select=AT, AT Form=DTR Dial, and the DTR signal transitions from off to on. This option also determines the telephone number dialed during restoral.
	Delay	<i>Buffer Delay</i>
AT*DB0	=Off	The Off setting disables the Delay option.
AT*DB1	=Buf or S38	This setting starts the buffer delay timer immediately upon detection of the disconnect request. When the timer is operating, the modem continues to process either the transmit or receive buffers. The modem disconnects when the buffers are empty or the timer expires, whichever occurs first. NOTE: When the modem is set for Direct mode, no data buffering occurs and the disconnect is immediate.
AT*DB2	=Buf & S38	This setting prevents the timer from starting until either the transmit or receive buffers have emptied. The modem then disconnects. Once the timer expires, when the modem is set to Direct mode, data is not buffered and the timer starts immediately.

Gray shading indicates country-specific options. See Appendix C for your country's options.

Table A-1.
AT Commands, Cross-Referenced to Front Panel Options (Continued)

AT Command	Parameter & Option	Description
AT*DB3	=S38	This setting allows the timer to start immediately upon detection of a disconnect request. The request continues to process either its transmit or receive buffers. The modem disconnects when the timer expires, regardless of the buffer states. NOTE: In Direct mode, no data buffering occurs. However, the modem delays a disconnect until the timer expires.
	DC	<i>Data Compression</i>
AT*DC0	=Disable	Data compression is not attempted.
AT*DC1	=Enable	Data compression is attempted. If the modem is using LAPM error correction, it uses V.42bis data compression when DC=Enabled . NOTE: In an application with SDC enabled, LAPM error correction and V.42bis data compression <i>only</i> are used. If your modem is using MNP error correction, it attempts to negotiate V.42bis and MNP-5 data compression with the remote modem. Depending on which data compression type can be accommodated by the remote modem, V.42bis or MNP-5 is used. Otherwise, no data compression is used.
	Dial Wait	<i>Dial Wait</i>
AT*DD0	=2 sec	The modem waits 2 seconds for a dial tone.
AT*DD1	=3 sec	The modem waits 3 seconds for a dial tone.
AT*DD2	=4 sec	The modem waits 4 seconds for a dial tone.
AT*DD3	=6 sec	The modem waits 6 seconds for a dial tone.
AT*DD4	=12 sec	The modem waits 12 seconds for a dial tone.
AT*DD5	=15 sec	The modem waits 15 seconds for a dial tone.
AT*DD6	=20 sec	The modem waits 20 seconds for a dial tone.
AT*DD7	=30 sec	The modem waits 30 seconds for a dial tone.
AT*DD8	=40 sec	The modem waits 40 seconds for a dial tone.
AT*DD9	=S7	Dial wait is determined by setting S-Register 7. (See the “S-Registers” section in Chapter 5).
	DTE Rate	<i>DTE Rate</i>
AT*DE2	=300	The DTE port is configured for 300 bps.
AT*DE4	=1200	The DTE port is configured for 1200 bps.
AT*DE5	=2400	The DTE port is configured for 2400 bps (this is the lowest rate available in SDC mode).
AT*DE6	=4800	The DTE port is configured for 4800 bps.
AT*DE7	=7200	The DTE port is configured for 7200 bps.
AT*DE8	=9600	The DTE port is configured for 9600 bps.
AT*DE9	=12.0	The DTE port is configured for 12,000 bps.
AT*DE10	=14.4	The DTE port is configured for 14,400 bps.
AT*DE11	=16.8	The DTE port is configured for 16,800 bps.
AT*DE12	=19.2	The DTE port is configured for 19,200 bps.
AT*DE13	=21.6	The DTE port is configured for 21,600 bps.
AT*DE14	=24.0	The DTE port is configured for 24,000 bps.
AT*DE25	=26.4	The DTE port is configured for 26,400 bps.
AT*DE26	=28.8	The DTE port is configured for 28,800 bps.
AT*DE15	=38.4	The DTE port is configured for 38,400 bps.

Gray shading indicates country-specific options. See Appendix C for your country's options.

Table A-1.
AT Commands, Cross-Referenced to Front Panel Options (Continued)

AT Command	Parameter & Option	Description
AT*DE23	=48.0	The DTE port is configured for 48,000 bps. Available with SDC feature only.
AT*DE24	=56.0	The DTE port is configured for 56,000 bps. Available with SDC feature only.
AT*DE16	=57.6	The DTE port is configured for 57,600 bps.
AT*DE17	=64.0	The DTE port is configured for 64,000 bps. Available with SDC feature only.
AT*DE18	=72.0	The DTE port is configured for 72,000 bps. Available with SDC feature only.
AT*DE19	=76.8	The DTE port is configured for 76,800 bps.
AT*DE20	=96.0	The DTE port is configured for 96,000 bps.
AT*DE21	=115.2	The DTE port is configured for 115,200 bps.
AT*DE28	=128.0	The DTE port is configured for 128,000 bps.
AT*DE22	=Auto	The modem uses the autobaud feature to determine the rate at which to operate. For details, see Chapter 5. NOTE: The Autobaud feature is not supported in synchronous operating modes. When configured for synchronous operation, if you select Auto, the DTE will be driven at the previous DTE rate selected (the factory default is 9600 bps).
	Data Form	<i>Data Format</i>
		Lets you specify the data encoding format to be used during SDC connections. NOTE: This option applies only to SDC data mode. It <i>does not</i> apply to synchronous ACUs (V.25bis or LPDA2) while disconnected. In the online mode, LPDA2 commands must follow the format of this option.
AT*DF0	=NRZ	The modem uses the NRZ data encoding format.
AT*DF1	=NRZI	The modem uses the NRZI data encoding format.
	L to D	<i>Leased to Dial</i>
		In an automatic restoral application, the originating modem uses the setting of this command as a trigger for automatic restoral. You select a threshold for the number of retrains to occur over a period of time. The originating modem initiates restoral if the number is exceeded.
AT*DI0	=Low/Fast	This is the most sensitive setting. It lets the modem initiate restoral when signal quality deteriorates slightly. <i>For V.34/V.32/V.32 Uncoded/V.32bis modulation modes</i> , 3 retrains must occur within 5 minutes before a dial restoral connection is established. <i>For other modulation modes</i> , 6 retrains must occur within 5 minutes before a dial restoral connection is established.
AT*DI1	=Low/Slow	<i>For V.34/V.32/V.32 Uncoded/V.32bis modulation modes</i> , 6 retrains must occur within 10 minutes before a dial restoral connection is established. <i>For all other modulation modes</i> , 12 retrains must occur within 10 minutes before a dial restoral connection is established.
AT*DI2	=High/Fast	<i>For V.34/V.32/V.32 Uncoded/V.32bis modulation modes</i> , 5 retrains must occur within 5 minutes before a dial restoral connection is established. <i>For all other modulation modes</i> , 10 retrains must occur within 5 minutes before a dial restoral connection is established.
AT*DI3	=High/Slow	<i>For V.34/V.32/V.32 Uncoded/V.32bis modulation modes</i> , 10 retrains must occur within 10 minutes before a dial restoral connection is established. <i>For all other modulation modes</i> , 20 retrains must occur within 1 minute before a dial restoral connection is established.
	RTS/CTS Delay	<i>RTS/CTS Delay</i>
		Sets the minimum interval for the delay time between RTS and CTS. These settings apply only when operating in the asynchronous Direct or synchronous data modes.
AT*DL0	RTS/CTS Delay=0	There is no RTS/CTS delay.
AT*DL1	=15	15-ms delay before the modem sends CTS to the DTE after receiving RTS from the DTE.
Gray shading indicates country-specific options. See Appendix C for your country's options.		

Table A-1.
AT Commands, Cross-Referenced to Front Panel Options (Continued)

AT Command	Parameter & Option	Description
AT*DL2	=60	60-ms delay before the modem sends CTS to the DTE after receiving RTS from the DTE.
AT*DL3	=90	90-ms delay before the modem sends CTS to the DTE after receiving RTS from the DTE.
AT*DL4	=S26	RTS/CTS delay is determined by the value of S-Register 26.
	Pause Delay	<i>Pause Delay</i> Makes the modem pause when it encounters modifiers in a dial string or on the command line.
AT*DP0	=3	Pause delay is 3 seconds.
AT*DP1	=6	Pause delay is 6 seconds.
AT*DP2	=9	Pause delay is 9 seconds.
AT*DP3	=12	Pause delay is 12 seconds.
AT*DP4	=S8	Pause delay is determined by S-Register 8. See the “S-Registers” section in Chapter 5.
	Auto Redial	<i>Auto Redial</i> Determines how many times the modem redials a failed call. The modem waits for a country-specific time between redials. If the AT *LN option is enabled, the modem dials all of the linked numbers before redialing.
AT*DR0	=Off	The modem does not redial an unsuccessful call.
AT*DRn	=n	The modem redials an unsuccessful call <i>n</i> times (<i>n</i> =1-15).
AT*DSn or AT*DS=n	Dial From Stored#	<i>Dialing a Stored Telephone number (n=1-9)</i> See the ATDS description earlier for information on using this command.
	DTR Delay	<i>DTR Delay</i> Determines how long the modem waits after connecting to the dial line before examining the DTR signal from the DTE. If the DTR signal is low, the modem disconnects. This feature is used when AT Form =SyncData or V25 Form=AsynSync.
AT*DT0	=S25	The modem waits for the time specified by S-Register 25 before examining DTR.
AT*DT1	=10 sec	The modem waits 10 seconds before examining DTR.
AT*DT2	=15 sec	The modem waits 15 seconds before examining DTR.
	EC	<i>Error Correction</i> The AT*EC (EC) command determines which error-correction protocol is used. NOTE: This option does not apply when the modem is configured for SDC operation. If both the local and remote modems are operating in SDC mode, LAPM error correction with V.42bis data compression <i>only</i> is used; no other setting is available.
AT*EC0	=V.42	The modems negotiate the use of LAPM or MNP error correction. First, the modems attempt to negotiate using LAPM. If unsuccessful, they attempt to negotiate using MNP.
AT*EC1	=LAPM	The modems attempt to negotiate LAPM error correction.
AT*EC2	=MNP	The modems attempt to negotiate MNP error correction.
	Fast Call	<i>Fast Call</i> Reduces the time for selected phases of the connect sequence.
AT*FC0	=Off	This option disables the Fast Call feature.
AT*FC1	=Lvl1	The 2.15 second billing delay in the answer modem is eliminated. The length of time ABT is sent is reduced by 1 second in all modulation modes except V.34.

Gray shading indicates country-specific options. See Appendix C for your country's options.

Table A-1.
AT Commands, Cross-Referenced to Front Panel Options (Continued)

AT Command	Parameter & Option	Description
AT*FC2	=Lvl2	Lvl2 applies to V.32 (coded or uncoded)/V.32bis modulation modes only. It includes the Lvl1 function and shortens training time by approximately 2 seconds.
AT*FC3	=Lvl3	Lvl3 includes the Lvl1 and Lvl2 function and eliminates error-correction negotiation, saving approximately an additional half second. For proper operation, enable this option and ensure that AT*SM (Mode), AT*EC (Error Correction), and AT*DC (Data Compression) (EC/DC OPT'S category) are set <i>the same</i> in both modems. NOTE: Selecting Lvl3 in the V.34 modulation mode bypasses error correction negotiation and improves the connect time of the modems as described above. If your local and remote modems are configured for SDC operation by selecting Fast Call Lvl3, the modems use LAPM error correction with V.42bis data compression <i>only</i> . For proper operation, enable this option in both modems, and ensure that the AT*SM (Mode) is set <i>the same</i> in both modems.
Flow		<i>Flow Control</i>
		Allows the modems and DTEs in a link to control the flow of data when buffers near their capacity. Use some type of flow control when operating in the Normal or Reliable mode. Check the DTE's manual to ensure that the DTE supports the type of flow control you select.
AT*FL0	=Off	Flow control is disabled.
AT*FL1	=XON/XOFF	The local modem and DTE operate flow control by passing characters embedded in the data stream between them. The XOFF character signals the transmitting device to stop sending data. The XON character lets the halted device start sending data. NOTE: XON/XOFF flow control is not supported in SDC mode.
AT*FL2	=DTR/CTS	<i>In asynchronous applications</i> , the local modem and DTE use DTR/CTS signals to operate flow control. <i>In SDC applications</i> , DTR/CTS flow control operates the same as asynchronous applications, except flow control is unidirectional from the local modem to the DTE through the CTS signal; the modem uses CTS to signal when the buffers are full. The DTR signal has no impact on flow control in synchronous applications.
AT*FL3	=RTS/CTS	<i>In asynchronous applications</i> , the local modem and DTE use RTS/CTS signals to operate flow control. The terminal uses RTS to signal when its buffers are full. The modem uses CTS to signal when its buffers are full. An on-to-off transition signals the transmitting device to stop sending data; an off-to-on transition signals that data can flow. <i>In SDC applications</i> , RTS/CTS flow control functions the same as asynchronous applications, except flow control is unidirectional from the local modem to the DTE through the CTS signal; the modem uses CTS to signal when the buffers are full. The RTS signal has no impact on flow control in synchronous applications.
AT*FL4	=XON/XOFF PT	XON/XOFF Pass-Through Flow Control. The local modem and DTE operate flow control by passing characters embedded in the data stream between them. Check your DTE manual to verify if the DTE recognizes XON/XOFF flow control. NOTES: 1) Pass-through flow control must be used with caution when Mode=Normal and Modem Flow=On because XON/XOFF characters are acted on by the remote modem at its DCE port. 2) Pass-through flow control <i>is not</i> applicable in 326X-SDC mode. If SDC is enabled, and you select XON/XOFF PT, the modem operates as if flow control were disabled.

Gray shading indicates country-specific options. See Appendix C for your country's options.

Table A-1.
AT Commands, Cross-Referenced to Front Panel Options (Continued)

AT Command	Parameter & Option	Description
AT*FL5	=TxClk	Transmit Clock. This option applies only in SDC mode. When the Tx Clk flow control option is selected, the modem uses a transmit clock for flow control based on available buffer space. The transmit clock is stopped when the buffers are full, inhibiting the flow of data from the DTE. It is started again when buffer space is available. NOTE: This option is operational only when internal timing has been selected (Clock=Internal, AT&X).
Hold DL Line		<i>Hold Dial Line</i>
		This command forces the modem to hold a dial restoral connection while testing a leased line connection. This command applies to modems configured for restoral.
AT*HD0	=Off	The Hold Dialline option is disabled; a dial modem configured for restoral disconnects from the dial line normally. A leased line modem configured for restoral disconnects from the dial line as soon as it connects to the leased line.
AT*HD1	=1min	A dial modem configured for restoral holds the dial line for 1 minute. A leased line modem configured for restoral holds the dial line for 1 minute while testing the leased line.
AT*HD2	=2min	
AT*HD3	=3min	
AT*HD4	=4min	
AT*HD5	=5min	
DTE Ct. 141		<i>DTE Circuit 141</i>
		Controls whether the local DTE can send the modem into a local analog loopback by sending a signal on V.24 Circuit 141 (Pin 18) to the modem. The DTE must support Circuit 141 in order to use this option.
AT*LA0	=Off	The modem does not respond to a signal on Circuit 141 (Pin 18).
AT*LA1	=On	An off-to-on transition on Circuit 141 (Pin 18) causes the modem to initiate a local analog loopback test. An on-to-off transition on V.24 Circuit 141 (Pin 18) takes the modem out of a local analog loopback test.
Line Compen		<i>Line Compensation</i>
		Enables the modem to compensate for the effects of low loss in the End Office-to-End Office connections.
AT*LC0	=Off	Disables the Line Compensation option.
AT*LC1	=On	Enables the Line Compensation option.
DTE Ct. 140		<i>DTE Circuit 140</i>
		Controls whether the local DTE can put the modem into a remote digital loopback by sending a signal on V.24 Circuit 140 (Pin 21) to the modem.
AT*LD0	=Off	The modem does not respond to a signal on V.24 Circuit 140 (Pin 21).
AT*LD1	=On	An off-to-on transition on V.24 Circuit 140 (Pin 21) sends the modem into a remote digital loopback test. An on-to-off transition on V.24 Circuit 140 (Pin 21) takes the modem out of a remote digital loopback test.
D to L		<i>Dial to Leased Option, Automatic Disconnect</i>
		Lets the modem automatically disconnect from the dial line and return to the leased line after a specified period.
AT*LE0	=Manual	Pressing the Talk/Data key (at the Home position) returns the modem to the leased line.

Gray shading indicates country-specific options. See Appendix C for your country's options.

Table A-1.
AT Commands, Cross-Referenced to Front Panel Options (Continued)

AT Command	Parameter & Option	Description
AT*LE1	=15 min	The modem returns to the leased line after 15 minutes.
AT*LE2	=30 min	The modem returns to the leased line after 30 minutes.
AT*LE3	=1 Hr	The modem returns to the leased line after 1 hour.
AT*LE4	=2 Hr	The modem returns to the leased line after 2 hours.
AT*LE5	=4 Hr	The modem returns to the leased line after 4 hours.
LAL Busy Out <i>Local Analog Loopback Test Busy Out</i>		
Determines whether the modem appears busy to incoming calls during a local analog loopback test. NOTE: Set AT&J (TELCO OPT'S Telco) to RJ4MB before enabling this option.		
AT*LL0	=Off	The modem does not busy out the line during a local analog loopback test, allowing incoming calls to ring.
AT*LL1	=On	The modem connects to the line during a local analog loopback test, making the line appear busy to incoming calls.
AT*LN _{m,n}	Link Phone #'s: #m to #n	<p><i>Link Telephone Numbers</i></p> <p>Lets you link telephone numbers stored in the modem's telephone book. Some remote locations provide more than one number to call in case one is busy. If a call fails and the number is linked, the modem pauses and then calls the linked number. NOTE: With this feature enabled, the modem dials linked numbers before redialing.</p> <p>To link numbers using the AT Command, enter AT*LN, followed by the memory location of the number you want to link from (n), a comma, and the memory location of the number to link (m). For example:</p> <p style="text-align: center;">AT*LN2,4</p> <p>In this example, memory location 2 is linked to memory location 4. To clear the link between the two memory locations, enter AT*LN2. Effectively, memory location 2 is now linked to no memory location.</p>
Low Speed <i>Low Speed</i>		
Determines which low-speed modulation mode is used when a higher (V.34, V.32bis, V.32, or V.22bis) modulation mode connection cannot be made while Mod=V.34 Auto, V.32bis Auto or Auto V32.		
AT*LS0	=Bell	Bell 103 modulation mode is used.
AT*LS1	=CCITT	V.21 modulation mode is used.
DTE Pin 25 <i>DTE Pin 25</i>		
Controls whether the modem uses EIA/TIA 232-D Pin 25 as an input or an output. Set rear panel Switch 2 to match this setting (see Table A-6 for details on rear panel switches).		
AT*LT0	=Busy	The DTE signals the modem on Pin 25 to make the modem appear busy to incoming calls. Set rear panel DIP switch 2 to the off (up) position. Also, set AT&J (Telco) to RJ4MB. NOTE: In modems in the U. S. A. and Canada, the Make Busy function operates only in nest card modems. (Make Busy settings display in standalone modems, but are not active.)
AT*LT1	=Test	The modem signals the DTE on V.24 Circuit 142 (Pin 25) when a test is in progress.
PSTN Signaling <i>PSTN Signaling</i>		
Determines how the modem handles disconnect signaling when operating in the V.34, V.32bis or V.32 (coded or uncoded) modulation modes.		
AT*MD0	=Off	Your modem disconnects without signaling the remote modem.
Gray shading indicates country-specific options. See Appendix C for your country's options.		

Table A-1.
AT Commands, Cross-Referenced to Front Panel Options (Continued)

AT Command	Parameter & Option	Description
AT*MD1	=On	Your modem signals the remote modem to disconnect by sending a PSTN clear-down.
	Modem Flow	<i>Modem Flow Control</i>
		Lets the modem generate and respond to XON/XOFF flow control signals received at the DIAL LINE or LEASED LINE port. NOTE: This option only applies to the Normal data transfer mode.
AT*MF0	=Off	The modem flow control is not used.
AT*MF1	=On	The modem periodically sends XON signals to the remote modem when it can receive data. When the modem cannot receive data, it sends an XOFF signal to the remote modem.
	Mod	<i>Modulation Mode</i>
		Determines the modulation mode used by the modem in data transmission. Changing modulation mode resets AT*MX (Max Rate) and AT*MN (Min Rate) to their defaults for the modulation mode selected. When you select a mode, ensure that the Max Rate AT*MX (Max Rate) and AT*MN (Min Rate) parameter options are within the valid range for the mode.
AT*MM0	=V32bis Auto	The modem negotiates the highest common connection in one of the following modulation modes: V.32bis, V.32 (coded or uncoded), V.22bis, Bell 212, V.21 or Bell 103 (depending on the Low Speed option).
AT*MM1	=Auto V32	The modem negotiates the highest common connection in one of the following modulation modes: V.32 (coded or uncoded), V.22bis, Bell 212, V.21 or Bell 103 (depending on the Low Speed option).
AT*MM2	Mod=V32bis Only	V.32bis or V.32 modulation mode is used.
AT*MM3	=V32 Only	V.32 modulation mode is used.
AT*MM12	=V32 Uncoded	V.32 modulation mode is used without the Trellis-coded Modulation (TCM) scheme. This selection reduces end-to-end data delay. With this selection (while operating at 4.8 bps), you do not have an embedded secondary channel (i.e., network management and remote configuration capability are not available).
AT*MM4	=V22bis Only	V.22bis modulation mode is used.
AT*MM5	=212 Only	Bell 212 modulation mode is used.
AT*MM6	=103 Only	Bell 103 modulation mode is used.
AT*MM7	=V21 Only	V.21 modulation mode is used.
AT*MM10	=V.34 Auto	The modem negotiates the highest common connection in one of the following modulation modes: V.34, V.32bis, V.32 (coded or uncoded), V.22bis, Bell 212, V.21 or Bell 103 (depending on the Low Speed option). This option does not display on the 3264V.32bis Series Modem.
AT*MM11	=V.34 Only	The modem negotiates the highest common connection in the V.34 modulation mode. This option does not display on the 3264V.32bis Series Modem.
	Min Rate	<i>Minimum Rate</i>
		Sets the minimum communication rate. Options vary with the modulation mode.
AT*MN0	=300	
AT*MN1	=1200	
AT*MN2	=2400	
AT*MN3	=4800	
AT*MN4	=7200	

Gray shading indicates country-specific options. See Appendix C for your country's options.

Table A-1.
AT Commands, Cross-Referenced to Front Panel Options (Continued)

AT Command	Parameter & Option	Description
AT*MN5	=9600	
AT*MN6	=12.0	
AT*MN7	=14.4	
AT*MN8	=16.8	(V.34 modems only)
AT*MN9	=19.2	(V.34 modems only)
AT*MN10	=21.6	(V.34 modems only)
AT*MN11	=24.0	(V.34 modems only)
AT*MN12	=26.4	(V.34 modems only)
AT*MN13	=28.8	(V.34 modems only)
AT*MN14	=31.2	(V.34 modems only)
AT*MN15	=33.6	(V.34 modems only)
DSR		<i>DSR Control</i>
		Determines how the modem sets the DSR signal.
AT*MR0	=Normal	DSR is controlled by the modem.
AT*MR1	DSR=High	DSR is always on.
AT*MR2	=DTR	DSR follows DTR.
AT*MR3	=Drop on Disc	The same as the normal setting except that when a disconnection is initiated from the local end, DSR is dropped immediately.
AT*MR4	=Sim LL	The same as the DTR setting except DSR is dropped when the remote modem requests a disconnect.
AT Msg		<i>AT Message</i>
		Determines when the AT connect message is sent to the DTE.
AT*MS0	=After CD	The AT connect message is sent to the DTE after DCD is raised.
AT*MS1	=Before CD	The AT connect message is sent to the DTE before DCD is raised.
Max Rate		<i>Maximum Rate</i>
		Sets the maximum rate at which the modems communicate over the analog network. Options available vary with the modulation mode.
AT*MX0	=300	
AT*MX1	=1200	
AT*MX2	=2400	
AT*MX3	=4800	
AT*MX4	=7200	
AT*MX5	=9600	
AT*MX6	=12.0	
AT*MX7	=14.4	
AT*MX8	=16.8	(V.34 modems only)
AT*MX9	=19.2	(V.34 modems only)
AT*MX10	=21.6	(V.34 modems only)
AT*MX11	=24.0	(V.34 modems only)
AT*MX12	=26.4	(V.34 modems only)

Gray shading indicates country-specific options. See Appendix C for your country's options.

Table A-1.
AT Commands, Cross-Referenced to Front Panel Options (Continued)

AT Command	Parameter & Option	Description
AT*MX13	=28.8	(V.34 modems only)
AT*MX14	=31.2	(V.34 modems only)
AT*MX15	=33.6	(V.34 modems only) (default)
	Buffers	<i>Buffer Option</i>
		Lets you specify whether normal or reduced size buffers store data received from a local DTE. Use this parameter if you have DTE-to-DTE flow control enabled, to reduce the amount of data sent to the remote DTE when a flow-off condition is received at the local DTE.
AT*NBO	=Regular	Normal capacity buffers are used.
AT*NB1	=Reduced	Reduced sized buffers are used allowing less data to accumulate in the modem.
		When the SDC modem is operating in synchronous reliable mode, selecting Buffers=Reduced reduces throughput delay while transmitting data.
	Netwrk Comp	<i>Network Compensation</i>
		Lets you enhance modem performance reliability when operating with network equipment.
AT*NC0	=Off	Off should be selected when making most normal connections within a continent.
AT*NC1	=Lvl1	Select Lvl1 if the modem is experiencing performance problems when connected to a line terminating equipment via a short loop, having low loop loss with below normal receive signal levels (for example, when operating behind a low grade PBX). NOTE: This option limits the maximum DCE data rate to 21,600 bps.
AT*NC2	=Lvl2	Lvl2 is recommended when performance problems are encountered making intercontinental calls. NOTE: This selection limits the maximum DCE data rate to 19,200 bps.
		When operating in an environment where the conditions described for Lvl1 and Lvl2 exist, Lvl2 is recommended to enhance performance.
AT*ND	View Phone #	<i>View Stored Telephone Numbers</i>
	=n	Lets you view the telephone numbers stored in the modem's nine telephone book addresses. Enter AT*ND<CR>
	Ext Cntrl	<i>External Control</i>
		Lets you select which pin the AT*OP (Ext Select) command responds to. NOTE: If AT*OP is set to 0, this command has no effect.
AT*OC0	=Pin 14	Loads an option set based on the transition of Pin 14. This setting overrides the AT*RE (Restore) command setting FP/116 or FP/116.ACU.
AT*OC1	=Pin 20	Loads an option set based on the transition of Pin 20. When using this setting, set the AT&D (DTR) command to High. This setting overrides the AT*RE (Restore) command settings FP/108.1 and FP/108.ACU and all AT&D (DTR) command settings except High.
	Ext Select	<i>External Option Set Select (also known as 116 Select)</i>
		Controls how the modem uses an external pin to select option sets. The pin used is defined by the AT*OC (Ext Cntrl) command.
AT*OP0	=Off	The AT*OP command is disabled.
AT*OP1	=1H/2L	There are 12 settings with the format nH-mL, where n=1, 2, 3, or 4, and m=1, 2, 3, or 4. When the pin specified by the Ext Cntrl option (14 or 20) transitions from low to high, the modem loads the "H" option set. When the pin specified by the Ext Cntrl option (14 or 20) transitions from high to low, the modem loads the "L" option set.
AT*OP2	=1H/3L	
AT*OP3	=1H/4L	

Gray shading indicates country-specific options. See Appendix C for your country's options.

Table A-1.
AT Commands, Cross-Referenced to Front Panel Options (Continued)

AT Command	Parameter & Option	Description
AT*OP4	=2H/1L	
AT*OP5	=2H/3L	
AT*OP6	=2H/4L	
AT*OP7	=3H/1L	
AT*OP8	=3H/2L	
AT*OP9	=3H/4L	
AT*OP10	=4H/1L	
AT*OP11	=4H/2L	
AT*OP12	=4H/3L	
	Overspeed	<i>Overspeed</i>
		Lets modem compensate when an async DTE sends data to the modem faster than specified.
AT*OS0	=1%	The modem compensates for DTE overspeed up to 1.0%.
AT*OS1	=2.5%	The modem compensates for DTE overspeed up to 2.5%.
	Password	<i>Enable/Disable Password Protection</i>
		Enables and disables the Password function. Once you have enabled the Password function, set protection in order to lock the modem (see AT *PF).
AT*PE0	=Disable	Disables the Password function.
AT*PE1	=Enable	Enables the Password function.
AT*PF	Set Protection	Lets you set protection to lock the modem. Refer to AT *PN for details.
AT*PN	Unlock Password Protection	<p>If you know your password, to unlock a password-protected modem and gain access to all modem functions, use the AT*PNxxxx command (where xxxx is the password).</p> <p>If you forget your password, you can regain access to all modem functions by performing the following procedure.</p> <p>IMPORTANT: <i>When you unlock a modem with this procedure, option settings and telephone numbers are deleted from modem memory. Before using the modem again, reconfigure option settings and re-enter stored telephone numbers.</i></p> <ol style="list-style-type: none"> 1) Close Switch 4 on the rear panel (set it to down position). See Tabl eA-6 for details. 2) In the Status/Option Sets/Dialing menu, press ► until Reinit Memory? displays 3) When you press Ⓞ, the modem displays Reinit All Mem? 4) Press Ⓞ again. The modem displays 326x Initial 5) The modem is now reset to factory default settings and all electronic telephone book entries are deleted. Password protection is disabled and the password is set to 0000. 6) To use the password protection feature again, open Switch 4 on the modem rear panel (set it to up position).
	Dial	<i>Dial Type</i>
AT*PT0	=Tone	The modem uses tone dialing unless otherwise specified by the T or P dial modifiers in a telephone number.
AT*PT1	=Pulse	The modem uses pulse dialing unless otherwise specified by the T or P dial modifiers in a telephone number.

Gray shading indicates country-specific options. See Appendix C for your country's options.

Table A-1.
AT Commands, Cross-Referenced to Front Panel Options (Continued)

AT Command	Parameter & Option	Description
AT*PT2	=Auto	The auto-call unit attempts to tone dial when initiating a call. If tone dialing is not possible, pulse dialing is used. For this feature to work correctly, the first character in a dial string must be a digit A T or P in the dial string overrides this setting, for that dial string.
AT*PWx/y	Change Password	Lets you change the modem's password. Enter: AT*PWold password/new password<CR> If successful, the modem responds with OK
	Rmt Acc	<i>Remote Access</i> Determines whether your modem can be configured by a remote modem.
AT*RA0	=Disable	The local modem cannot be configured by a remote modem.
AT*RA1	=Enable	The local modem can be configured by a remote modem.
	Rmt Cnfg	<i>Initiate/Terminate, or Abort Remote Configuration Session</i> Lets you initiate, terminate, or abort a remote configuration session with the connected modem.
AT*RC0	=Terminate	The modem terminates a remote configuration session with the connected modem. Changes to the remote modem's configuration are saved. This setting is not displayed unless you are already in a remote configuration session.
AT*RC1	=Abort	The modem aborts a remote configuration session with the connected modem. Changes made to the remote modem's configuration are not saved. This setting is not displayed unless you are already in a remote configuration session.
AT*RC2	Init Rmt Cnfg?	The modem attempts to initiate a remote configuration session with the connected modem. For instructions on initiating a remote configuration session with a dial/leased line modem, or terminating or aborting a remote configuration session, refer to Chapter 1 of the <i>326X Series Modem Reference Guide</i> .
AT*RDn	Redial Last Number	With this command, the modem redials a call until a successful connection is made or the call has been attempted <i>n</i> times. This command causes your modem to redial the <i>last</i> number dialed.
	Restore	<i>Initiate/Terminate Restoral</i> Determines how modems operating on a leased line handle initiation of a dial restoral session. The modem has four ways of initiating restoral: automatic, manual, DTE signal, or DTE ACU. The restoral option is available in models: 3261, 3263, 3266, and the 3268.
AT*RE0	=Off	Disables the initiation of restoral.
AT*RE1	Restore=FP Only	Manual initiation lets you initiate and terminate restoral by pressing the Talk/Data key (Ⓢ key in the Home position) on the modem's front panel.
AT*RE2	=FP/108.1	The modem lets the DTE initiate restoral using DTR. In DTR restoral, an off-to-on DTR transition from the DTE interface initiates restoral. This option is provided for DTEs that cannot manipulate Circuit 116 for restoral purposes.
AT*RE3	=FP/116	The modem allows the DTE to initiate restoral with Circuit 116. Circuit 116 lets you use off-to-on transitions of this signal from the DTE to initiate restoral, according to ITU V.24 specifications.
AT*RE4	=FP/Auto	In automatic restoral, the originating modem on the leased line determines when restoral takes place. The answer modem cannot automatically initiate restoral; it can only answer an inbound call, thus ensuring that both modems do not try to call each other at the same time. Such an occurrence would result in a failed restoral attempt.

Gray shading indicates country-specific options. See Appendix C for your country's options.

Table A-1.
AT Commands, Cross-Referenced to Front Panel Options (Continued)

AT Command	Parameter & Option	Description
AT*RE5	=FP/108.ACU	With this option, off-to-on transitions of this signal from the DTE activate the ACU. This lets the modem accept dial commands. With this option, either modem can enable the ACU when the connected DTE turns Circuit 116 from off to on.
AT*RE6	=FP/116.ACU	With this option, off-to-on transitions of this signal from the DTE activate the ACU. This lets the modem accept dial commands to initiate restoral. With this option, either modem can enable the ACU when the connected DTE turns Circuit 116 from off to on.
	Parity	<i>Parity</i> When using the ASCII character set, you must select the parity used by the modem and DTE. The Parity option applies to asynchronous and character-synchronous data formats. When set to V.25, the following applies: <i>Async:</i> 7 Data Bits, Parity=even, Stop Bits=1 <i>Bitsync:</i> 7 Data Bits, Parity=space, Stop Bits=1 or 8 Data Bits, Parity=none, Stop Bits=1 <i>Charsync:</i> 7 Data Bits, Parity=odd, Stop Bits=1
AT*RP0	=V.25	<i>Charsync:</i> 7 Data Bits, Parity=odd, Stop Bits=1
AT*RP1	=Even	7 Data Bits, Parity=even, Stop Bits=1
AT*RP2	Parity=Odd	7 Data Bits, Parity=odd, Stop Bits=1
AT*RP3	=Mark	7 Data Bits, Parity=mark, Stop Bits=1 or 7 Data Bits, Parity=none, Stop Bits=2
AT*RP4	=Space	7 Data Bits, Parity=space, Stop Bits=1 or 8 Data Bits, Parity=none, Stop Bits=1
	RTS	<i>RTS Control</i> The AT*RS command determines how the modem interprets the RTS signal. The DTE signals the modem with RTS on EIA/TIA 232-D Pin 4 (V.24 Circuit 105).
AT*RS0	=Normal	The DTE controls data transmission with RTS.
AT*RS1	=High	The modem sets RTS high. Use this setting if the DTE does not provide RTS. If you are using Normal or Reliable data transfer mode and you are using RTS/CTS flow control, this setting is overridden and RTS operates as if RTS=Normal.
AT*RS2	=Remote	This setting applies to simulated half-duplex applications and works only if the remote modem also supports RTS/DCD signaling. For this application to work properly, the DCD option at the remote site must be set to Remote. Coordinate your setting with the remote site.
	Retrain	<i>Auto Retrain</i> Enables the auto-retrain feature. When enabled, the modem retrains if the specified bit error rate is exceeded. Enable Retrain for most applications because retrains allow the modem to compensate for changing line conditions.
AT*RT0	=Off	The modem does not automatically initiate retrains, but responds to retrains from the remote modem.
AT*RT1	=Low BER	The Low BER setting is more sensitive than the High BER setting. Using V.34, V.32bis, V.32, or V.32 Uncoded, the modem retrains when the bit error rate (BER) exceeds approximately 10^{-4} for eight seconds. Using V.22bis, the modem retrains when the bit error rate (BER) exceeds approximately 10^{-4} for one second.
Gray shading indicates country-specific options. See Appendix C for your country's options.		

Table A-1.
AT Commands, Cross-Referenced to Front Panel Options (Continued)

AT Command	Parameter & Option	Description
AT*RT2	=High BER	The High BER setting is less sensitive than the Low BER setting. NOTE: Telenetics recommends this setting for most applications. Using V.34, V.32bis, V.32, or V.32 Uncoded, the modem retrains when the bit error rate (BER) exceeds approximately 10^{-3} for eight seconds. Using V.22bis, the modem retrains when the bit-error rate (BER) exceeds approximately 10^{-3} for one second. When ARS is enabled, bit error rate is always used.
Speed Conver		<i>Speed Conversion</i> Determines whether the modem uses the speed conversion feature. This option does not apply when the modem is in the Direct or synchronous data transfer mode.
AT*SC0	=Off	The modem adjusts its DTE port speed to match the speed of the negotiated data link.
AT*SC1	=On	DTE-to-modem speed remains constant, regardless of the negotiated data link speed. (The exception is Direct data mode, where the DTE-to-modem speed always matches the modem-to-modem speed.)
Inactivity		<i>DTE Inactivity</i> Lets you select how long the modem waits before disconnecting, when no data is transferred. This option does not apply when the modem is set for the synchronous data transfer mode.
AT*SI	=Off	The Off option disables the inactivity timer.
AT*SI1	=3min	The modem disconnects if 3 minutes elapses without data transfer to or from the DTE.
AT*SI2	Inactivity=10min	The modem disconnects if 10 minutes elapses without data transfer to or from the DTE.
AT*SI3	=20min	The modem disconnects if 20 minutes elapses without data transfer to or from the DTE.
AT*SI4	=30min	The modem disconnects if 30 minutes elapses without data transfer to or from the DTE.
AT*SI5	=S30min	The inactivity timeout is controlled by the value set in S-Register 30.
EC ID		<i>Error Correction ID</i> Sets the ID number that modems exchange when they attempt to establish an MNP link.
AT*SL0	=Default	The modem identifies itself with a generic MNP identification number. Use this option unless you are certain that the remote modem(s) is a Telenetics or Motorola modem.
AT*SL1	=Codex	The modem identifies itself with a special MNP identification number. This allows one Telenetics or Motorola modem to recognize another during an MNP link negotiation.
Mode		<i>Data Transfer Mode</i> Sets the data transfer mode for asynchronous applications, or for synchronous applications with the 326X-SDC. The setting governs the modem's use of error correction. NOTE: To enable SDC, select one of the reliable data transfer modes (Mode=Reliable, Auto Reliable, or Speed Dependent Auto Reliable).
AT*SM0	=Direct	In Direct mode (asynchronous or synchronous), the modem does not use error correction. In Direct mode, EC/DC OPT's menu options are disabled. In data mode, the DTE speed must match the modem speed.
AT*SM1	=Normal	In normal mode (asynchronous), the modem does not use error correction or data compression. The break type is assumed to be standard. In data mode, the modem uses speed conversion (if enabled). This lets the modem automatically accommodate DTEs of different speeds. Enable terminal flow control and Modem Flow when operating in Normal mode. Selecting Mode=Normal results in a Direct synchronous connection in the SDC mode.

Gray shading indicates country-specific options. See Appendix C for your country's options.

Table A-1.
AT Commands, Cross-Referenced to Front Panel Options (Continued)

AT Command	Parameter & Option	Description
AT*SM2	=Reliable	In an asynchronous application, once the local modem connects with the remote modem, it attempts to establish an error-corrected link. In Reliable data mode, the modem uses speed conversion (if enabled). The local modem disconnects if it cannot establish an error-corrected link. Enable the terminal flow control when operating in reliable mode. If the modem negotiates a connection in the V.21 or Bell 103 modulation mode, it terminates the call. If operating with SDC enabled in both modems, once the local modem connects with the remote modem, it attempts to establish an error-corrected link. In SDC mode, the Data Compression (AT*DC) and Error Correction (AT*EC) options are ignored; a connection is attempted using V.42bis data compression and LAPM error correction. The local modem establishes a synchronous Reliable connection or disconnects if it cannot establish an error-corrected link. In Reliable data mode, the modem uses speed conversion (if enabled). Enable the terminal flow control when operating in reliable mode. If the modem negotiates a connection in the V.21 or Bell 103 modulation mode, it terminates the call. In Reliable data mode, leased-line operation, the modem initiates a retrain if the error-correction function does not establish a reliable link within 30 seconds.
AT*SM3	=Auto-Reliable	Once the local modem connects with the remote modem, it attempts to establish an error-corrected link. In Auto-Reliable data mode, the modem uses speed conversion (if enabled). This lets the modem automatically accommodate DTEs of different speeds. The modem reverts to Normal mode if it cannot establish an error-corrected link. In SDC mode, with the Auto Rel option, the modem reverts to Direct mode if it cannot establish an error-corrected link. Enable terminal flow control when operating in the Auto-Reliable mode. If the local modem negotiates a connection in the V.21 or Bell 103 modulation mode, Normal mode is used in asynchronous applications; Direct mode is used in synchronous applications.
AT*SM4	=Spd AutoRel	Speed-Dependent Auto-Reliable. Once the local modem connects with the remote modem, it attempts to establish an error-corrected link. If a connection is established at 1200 bps or less, Normal mode is used in async applications; Direct mode is used in sync applications. In data mode, the Speed-Dependent Auto-Reliable mode uses speed conversion (if enabled). This lets the modem automatically accommodate DTEs of different speeds. Enable terminal flow control when operating in the Auto-Reliable mode.
	RemRTS/DCD	<i>RTS/DCD Remote Signaling</i> This command allows for two types of PN signaling. It is valid when RTS or DCD =Remote.
AT*SR0	= Codex	The Codex setting lets you configure the modem for Telenetics- or Motorola-proprietary signaling.
AT*SR1	= V.13	This setting allows ITU V.13-compliant signaling for synchronous applications only.
AT*ST0	Long-form status	Refer to AT&V for a description of the AT*ST command.
AT*ST1	Short-form status	
	TpDlyMin	<i>Throughput Minimization Delay</i> Lets you improve modem performance in SDC mode by minimizing delays during data transmission. This feature, when enabled, lets the remote modem, only, begin transmitting synchronous data to its DTE, before an entire frame of data has been received from the local modem. This option applies only when the modem is operating in SDC mode.
AT*TD0	=Off	Throughput Delay Minimization is disabled. With this setting, the remote modem waits until it has received an entire frame of data before beginning to transmit the data to its DTE.

Gray shading indicates country-specific options. See Appendix C for your country's options.

Table A-1.
AT Commands, Cross-Referenced to Front Panel Options (Continued)

AT Command	Parameter & Option	Description
AT*TD1	=Rx Clock	With this setting, the remote modem uses its internal Rx Clock to control the flow of data from the modem to the DTE, preventing a loss of synchronization during data transmission. This setting lets the remote modem begin transmitting data before an end-of-frame has been received from the local modem. If the rate of data transmission slows, the clock stops, temporarily ceasing the flow of data. Telenetics recommends that the Rx Clock setting be used in most applications. NOTE: This setting is operational only when Clock=Internal (AT&X).
AT*TD2	=RxD Dly	With this setting, the remote modem continuously monitors and adjusts line traffic to estimate (based on time) when to transmit data to the DTE. The modem calculates a delay time based on variables such as frame size, DTE rate, DCE rate, and data compression ratio. The remote modem waits this time before transmitting data to its DTE. NOTE: Due to variable line conditions or varying types of data, frame losses could result with this selection.
	Tone Length	<i>Tone Length</i> Determines the time duration of the DTMF (Dual Tone Multifrequency) tone. This command is operational only when tone dialing is selected using dial modifiers or the ATT command.
AT*TL0	=72	Tone length is 72 ms.
AT*TL1	=S11	The tone length is determined by S-Register 11. See Appendix C for your country's options.
	Call Timeout	<i>Call Timeout</i> Determines how long the modem waits from the time it completes dialing to the time it detects answer-back tone from the remote modem. If the modem does not receive answer-back tone from the remote modem within the specified time, the modem disconnects.
AT*TT0	=30	The modem waits 30 seconds for a call to succeed.
AT*TT1	=45	The modem waits 45 seconds for a call to succeed.
AT*TT2	=60	The modem waits 60 seconds for a call to succeed.
AT*TT3	=90	The modem waits 90 seconds for a call to succeed.
AT*TT4	=180	The modem waits 180 seconds for a call to succeed.
AT*TT5	=S7	The modem waits the amount of time specified by S-Register 7 for a call to succeed. See Appendix C for your country's options.
	RelMsg	This command applies to the Reliable and Auto-Reliable data transfer modes only. The local modem can send a reliable message to the DTE along with the normal connect message if both modems negotiated a reliable (error-corrected) connection.
AT*XC0	=Off	If enabled, the modem sends a connect message to the DTE, but it does not send the reliable portion of the connect message. A typical connect message is CONNECT 9600.
AT*XC1	=Short	The modem sends a reliable connect message to the DTE when a reliable connection is successful. The message indicates the local DTE-to-modem data rate, but no error correction or data compression is included. Atypical short reliable connect message is CONNECT 9600 RELIABLE.
AT*XC2	=Long	The modem sends a reliable connect message to the DTE when a connection is successful. The message indicates that the local DTE-to-modem data rate, as well as the error-correction and data-compression schemes, are being used. A typical long reliable connect message is CONNECT 9600 RELIABLE EC=(LAPM) DC=(V42bis).
<i>Gray shading indicates country-specific options. See Appendix C for your country's options.</i>		

Table A-1.
AT Commands, Cross-Referenced to Front Panel Options (Continued)

AT Command	Parameter & Option	Description
	Callback	<i>Callback Feature</i>
		Determines the source of the telephone number that your modem calls when it receives a valid access security password from the remote modem.
		NOTE: For details on access security and call features, see Chapter 2 of the <i>326X Series Modem Reference Guide</i> .
AT*ZC0	=Off	Callback is disabled.
AT*ZC1 – 9	=Intern 1 – 9	The answer modem performs the callback using the phone number stored in the specified location (even if the calling modem provides a callback number).
AT*ZC10	=Remote	The answer modem performs the callback using a number <i>provided by the remote user</i> . If the calling modem does not provide a callback number and the password is valid, the modem attempts a connection, without hanging up or calling back.
Only accessible from an NMS	=Manager	The NMS performs the callback using a phone number stored in its database that is associated with the received ID code. This option is not accessible from the front panel or AT ACU and displays only when selected by an NMS.
AT*ZC12	=Rmt Ind	The answer modem performs the callback using the phone number stored at the specified phone number index <i>provided by the remote user</i> (1 – 9). If the remote device does not provide a callback index, the modem attempts to establish a connection without hanging up or calling back if AT*ZR0 (Rmt Num Rqrd=Off) is set.
	DialRstrct	<i>Dial Restricted</i>
		This command defines dial command limitations.
AT*ZD0	=Off	No dial restrictions exist.
AT*ZD1	=Lv11	The auto redial command is not allowed. The A/ command is not allowed if the previous command was a dial command. In both cases, the modem reports an ERROR message to the DTE.
AT*ZD2	=Lv12	Lv12 has the same function as Lv11. In addition, only stored phone numbers may be dialed. The ATD, V.25bis CRN, LPDA2 Hex 21, and the front panel Enter Then Dial options are not allowed.
AT*ZI	Enter Group PW?	<i>Enter Access Security Group Password</i>
		Lets you enter the password that your modem uses for access security.
		Enter AT*ZIx<CR> , where <i>x</i> =maximum 10 characters; minimum one character
		From the front panel, enter alphanumeric characters.
		NOTE: For a detailed description of the modem's access security and call features, refer to Chapter 2 of the <i>326X Series Modem Reference Guide</i> .
	Tone	<i>Select Tones with Access Security</i>
		Controls the type of tones used by your modem to alert the caller to expect a callback and to enter the access security password.
AT*ZP0	=None	No tones are generated by the answer modem.
AT*ZP1	=Prompt Only	Upon answering a call, the local modem sends the caller a dial tone. This is a prompt for the caller to enter the access security password. This setting is intended for manual dialing only.
		The dial tone lasts for the amount of time specified by S-Register 45. The caller must enter the access security password in the amount of time specified by S-Register 46.

Gray shading indicates country-specific options. See Appendix C for your country's options.

Table A-1.
AT Commands, Cross-Referenced to Front Panel Options (Continued)

AT Command	Parameter & Option	Description
AT*ZP2	=Ack Only	After validating the password, the modem generates an acknowledgment tone before hanging up. This indicates to the caller that the access security password is valid and that the modem should expect to receive a callback. Upon hearing the tone, the caller should hang up immediately. This setting is intended for callback only.
AT*ZP3	=Prompt/Ack	Upon answering a call, the local modem generates both the prompt and acknowledgment tone at the appropriate times. This setting is intended for manual dialing only. NOTE: For a detailed description of how the modem's access security and call features operate, refer to Chapter 2 of the <i>326X Series Modem Reference Guide</i> .
	Rem Num Rqrd	<i>Remote Number Required</i> Specifies whether a remote callback number is required when using AT*ZC (Callback). NOTE: For a detailed description of how the modem's access security and call features operate, refer to Chapter 2 of the <i>326X Series Modem Reference Guide</i> .
AT*ZR0	=Off	A remote callback number is not required. If the calling modem does not provide a callback number, the modem attempts to establish a connection without hanging up or calling back.
AT*ZR1	=On	A remote callback number is required. The modem does not attempt to make a connection or callback if no callback number is provided.
	Sim Ring	<i>Simulated Ringback</i> Determines whether the answer modem sends a ringback tone to the calling modem prior to sending an answer-back tone immediately after entering the access security password. NOTE: For a detailed description of how the modem's access security and call features operate, refer to Chapter 2 of the <i>326X Series Modem Reference Guide</i> .
AT*ZS0	=Disable	No ringback tone is sent to the remote modem prior to sending an answer-back tone.
AT*ZS1	=Enable	After receiving the access security password, the answer modem sends a ringback tone to the remote modem (prior to sending an answer-back tone).
	PW Verify	<i>Password Verification</i> This command determines whether the access security feature is enabled. If access security is enabled, this option selects the method used to verify a password. NOTE: For a detailed description of how the modem's access security and call features operate, refer to Chapter 2 of the <i>326X Series Modem Reference Guide</i> .
AT*ZV0	=Dis	Password and callback features are disabled.
AT*ZV1	=Intern	A single password, stored in modem memory, is checked against the received password. This password is stored in modem memory using the AT *ZI (Enter Group PW?) command.
Only accessible with an NMS	Mngr	The network management system verifies the received password. Although displayed at the modem, this selection is not accessible by the front panel or AT ACU.
<i>Gray shading indicates country-specific options. See Appendix C for your country's options.</i>		

Table A-2.
Front Panel Configuration Options

326X Menu	Parameter & Option	Description
ACU OPT'S	ACU Select	Determines which Auto-Call Unit (ACU) the modem uses. To enable SDC: select an ACU (ACU Select), a bit-synchronous data format (for the AT and V.25bis ACUs), and Mode=Reliable, Auto Reliable, or Speed Auto Reliable (AT*SM).
	=AT	The AT auto-call unit is used.
	:V25b	To enable SDC: after selecting AT ACU, select a data format (AT&M). The options are: Sync Data, DTR Dial, or Man Dial. Refer to the AT&M option description in Table A-1. The V.25bis auto call unit is used.
	:LPDA2	To enable SDC: after selecting V25b, select a data format (AT&M). The options are: AsynSync or Bitsync (see next parameter, below). The LPDA-2 auto-call unit is used.
	:None	After selecting LPDA (LPDA transmits data synchronously), to enable SDC, select Mode=Reliable, Auto Reliable, or Speed Auto Reliable (AT*SM). No auto call unit is used.
	V25Form	To enable SDC: after selecting None, choose a synchronous data format using the NoACU Form option (discussed later in this table). Determines the format of data when the ACU Select option is set to V25b.
	=Async	To enable SDC: after selecting V.25bis ACU, choose one of the synchronous data formats (AsynSync or Bitsync). Select Mode=Reliable, Auto Reliable, or Speed Auto Reliable (AT*SM). Modem is compatible with asynchronous DTEs.
	: AsynSync	Modem dials calls asynchronously, but data is passed synchronously.
	:Bitsync	The DTE uses the bit-synchronous, HDLC-like protocol outlined in the ITU V.25bis specification.
	: Charsync	The DTE uses the character-synchronous protocol outlined in the ITU V.25bis specification. NOTE: Charsync is not available for the SDC operating mode.
	NoAcu Form	This option determines the format of data when ACU Select=off.
	=Async	To enable SDC: after selecting ACU Select=None, choose NoAcu Form=Sync. Select Mode=Reliable, Auto Reliable, or Speed Auto Reliable (AT*SM). Asynchronous data is passed in data mode.
	:Sync	Synchronous data is passed in data mode.
	Char Length	Applies to asynchronous data applications that use the direct data transfer mode (no error correction). The modem ignores this option in the normal, reliable, or auto-reliable data transfer modes.
	=8	Do not change this option unless your application requires it. If you must change it, select the option that corresponds to the number of bits that your DTE uses to code a character (start bit, data bits, parity bit, and stop bit) NOTE: Autobauding works only with 10-bit characters. Modem is compatible with 8-bit characters.
	:9	Modem is compatible with 9-bit characters.
	:10	Modem is compatible with 10-bit characters.
	:11	Modem is compatible with 11-bit characters.
	V25 Char	Determines the type of character the V.25bis ACU uses.
	=ASCII	The V.25bis ACU uses ASCII character format.
	:EBCDIC	The V.25bis ACU uses EBCDIC character format.

Gray shading indicates country-specific options. See Appendix C for your country's options.

**Table A-2.
Front Panel Configuration Options (Continued)**

326X Menu	Parameter & Option	Description
	Sync Idle	Applies to synchronous applications only (direct synchronous or SDC operating modes). Your modem sends Marks or Characters on EIA/TIA 232-D Pin 3 (V.24 Circuit 104) to the DTE when it has no messages to send.
	=Mark	Modem sends continuous Marks (or one bits) on EIA/TIA 232-D Pin 3 (V.24 Circuit 104) to the DTE when it has no messages to send.
	:Char	Applies to V.25bis, and LPDA2 ACUs. <i>If the modem is configured for V.25bis and V25Form=Charsync, it sends a continuous stream of SYN (synchronizing) Characters on EIA/TIA 232-D Pin 3 (V.24 Circuit 104) when it has no messages to send. If V25Form=Bitsync, it sends continuous flags (7E hexadecimal) when it has no messages to send.</i> <i>If the modem is configured for LPDA2, it sends continuous flags (7E hexadecimal) when it does not have a message to send.</i>
	V25 Resp	When using the V.25bis ACU, the modem always indicates a valid connection after the local modem and remote modem switch to data mode. You can receive an indication of call progress at your DTE. The V25 Resp option chooses the response you receive.
	=V25bis	The modem sends a VAL message upon receipt of the dial command and a CNX message once an answer-back tone is received from the remote modem.
	:V25rate	The modem sends a VAL message upon receipt of the dial command and a CNX message followed by the data rate once the modem switches to data mode.
	:VALOnly	The modem sends a VAL message when the modems switch to data mode.
	V25 Resp:	The modem does not send a message to the DTE.
	LPDA2 Addr	Lets you select the modem's address. (See Chapter 2 of the <i>326X Series Modem Reference Guide</i> for details.)
	LPDA2 ID	Allows the modem type to be returned in the data field response field.
	=326X	Sends 3260 in data response.
	:7855	Sends 7855 in data response.
	LPDA2 Det	
	=Enab	LPDA2 commands are recognized in the data stream and the commands are processed.
	:Disab	LPDA2 command frames are not recognized as commands.
TELCO OPT'S	DL TX Level	Displays the modem's dial line transmit level, which is set for your country's requirements.
	=0 to -15	The modem is set to transmit at a level in the 0 to -15 dBm range.
	LL TX Level	Displays the modem's leased line transmit level, which is set for your country's requirements.
	=0 to -15	The modem is set to transmit at a level in the 0 to -15 dBm range. Adjustable Transmit Levels—V.34 Modulation Mode In the V.34 modulation mode, the local and remote modems negotiate a transmit level (for the dial/leased line) during the training sequence. This allows the modems to select the lowest possible transmit level in order to maximize the signal to echo level in the receiver. A typical range for the reduction of the transmit level is 0 to -14 dBm. NOTE: Although the modem negotiates a transmit level that may differ from the rate indicated for your country, the front panel DL TX and LL TX Levels options remain the same. The CQMS parameter, Tx Level, however, displays the actual transmit level in use for a connection.

Gray shading indicates country-specific options. See Appendix C for your country's options.

Table A-2.
Front Panel Configuration Options (Continued)

326X Menu	Parameter & Option	Description
ACCESS SECURITY	Group PW	Determines if the modem can verify a received password when PW Verify=Mngr (AT*ZV) and the network management system is unable to perform the verification. This option is not accessible from the front panel or the AT ACU. It is displayed for status purposes only.
	=Disable :Enable	The modem cannot verify the password. The modem can verify the password using its Group PW stored internally.
NETWK CNTL OPT'S	OverrideMode	Determines whether your modem can be controlled by the network manager.
	=Off :On	The network manager can attach your modem. When it has attached, front panel control is locked out. You can display options and status in the front panel menu tree, but you cannot change options. If you attempt to change a setting, the modem displays Net Man Attached. The network manager cannot attach your modem.
	NC Address	Lets you set the modem's network control address. This is the address that modems use with the SET RMT LL ADDR and SRCH RMT LL ADDR functions. The range of addresses is 0 to 254. To set a network control address, see "Performing Numeric Entry" in this appendix.
	NC PortRate	Set the NC Port Rate option to match the speed of your network manager. This option controls the speed of the NC ports on your modem's rear panel.
	= 75 : 110 : 150 :1200 :2400 :4800 :9600	Configures the network control port for speeds indicated in bits per second (bps).
	Pass Thru	The modem uses an in-band secondary channel to pass network management data to the remote modem. The channel is not disruptive to main channel user data. Pass Thru controls how network control data is passed to the remote modem when the modem is configured as DIAL.
	=opt 1	The local modem (connected to a network manager through the NC port) does not forward <i>all</i> network management data received from the NC port to the remote modem over the in-band secondary channel. Only commands from the network manager to the remote modem are passed through. Only remote-modem responses are passed to the network manager.
	=opt 2	The modems do no filtering. They pass all network management data received from the NC port to the in-band secondary channel and from the in-band secondary channel to the NC port.
	SET RMT LL ADDR	New Address=nnn Rmt Ser#=nnnnnnn Rmt Nest Modem=No, A, B.
SRCH RMT LL ADDR	Rmt Ser#=nnnnnnn Rmt Nest Modem=No, A, B.	The SRCH RMT LL ADDR menu is for use with remote configuration on leased lines. Using this option, you can search for the remote modem's address.

Gray shading indicates country-specific options. See Appendix C for your country's options.

Performing Numeric Entry

The following options require you to enter information using the front panel or ACU.

Front Panel Option	Description
Enter Phone #=n	Stores phone number to phone book memory in location n.
Enter Then Dial	Lets you dial from the front panel.
S-Reg xxx=nnn	Lets you set S-Register xxx to nnn.
LPDA-2 Addr=nnn	Lets you set the LPDA2 address.
Enter PW:nnnn	Lets you unlock a modem's password protection.
Old PW:nnnn	Lets you enter old password.
New PW:nnnn	Lets you configure new password.
Verify PW:nnnn	Lets you verify new password.
Enter Group PW:	Lets you verify group password.
NC Address:nnn	Lets you set network control address.
New Address:nnn	Lets you set remote modem's leased line address.
Rmt Ser:nnnnnn	Lets you enter remote modem's serial number.

The keystrokes to set the numeric entry for these options are as follows:

- 1) Step across the front panel menu by pressing ► until the option you want to change displays.
- 2) Press Ⓞ. You are now ready to key in the numeric entry.
- 3) Press ▼ until the digit or character you want appears in the leftmost position of the display.
Example: 1xxxxx
- 4) Press ►. The display shifts one position to the left, and the second character position is displayed.
- 5) Repeat Steps 3 and 4 until you have completed keying in the numeric entry. To re-enter a number or character, press ⚡ to place the cursor at the beginning of the line, then re-enter the number or character.
- 6) Press Ⓞ to save your selection.

S-Register/AT Command Cross-Reference

This section shows the modem's S-Registers cross-referenced with AT Commands and front panel options. (For details on S-Registers, refer to Chapter 5, Using the AT Automatic Calling Interface.)

Table A-3.
S-Register Cross-Reference

S-Register	AT Command	Front Panel Option
S0—Ring Count to Answer On	AT*AA5	Answer=Using S0
S1—Ring Count	—	—
S2—Escape Code Character	—	—
S3—Carriage Return Character	—	—
S4—Line Feed Character	—	—
S5—Backspace Character	—	—
S6—Wait for Dial Tone	AT*BD2	Blind Dial=S6
S7—Wait for Data Character	AT*DD9	Dial Wait=S7
S7—Wait for Data Character	AT*TT5	Call Timeout=S7
S8—Pause Time for Pause Delay Dial Modifiers	AT*DP4	Pause Delay=S8
S10—Carrier Loss Hang Up Delay	AT*CD3	DCD Loss Dis=S10
S11—DTMF Tone Duration	AT*TL1	Tone Length=S11
S12—Escape Code Guard Time	—	—
S18—Test Timer	—	—
S25—Delay Before Looking for DTR	—	—
S26—RTS/CTS Delay	AT*DL4	RTS/CTS Delay=S26
S30—DTE Inactivity Disconnect	AT*S15	Inactivity=S30
S38—Disconnect Buffer Delay	AT*DB3	Delay=S38
S45—Access Security Tone Duration	—	—
S46—Access Security Lead Digit Delay Timeout	—	—
S96—Signalling System #5	AT*S96	=0 to 1
S97—Break Signal Duration	AT*S97	=0 to 39
S98—AC Detect	AT*S98	=0 to 1
S99—V.32 Training Time	AT*S99	=0 to 216

Dial Modifiers for Special Dialing Requirements

When entering telephone numbers into modem memory or dialing directly from the modem's front panel, you can add dial modifiers to telephone numbers. Table A-4 lists the dial modifiers used in AT ACU applications.

Table A-4.
Dial Modifiers

Modifier	Function	Description
W w :	Dial Wait	Instructs the modem to stop and wait for a dial tone. If the modem does not detect a dial tone after a specified period, it aborts the call. The factory default for dial wait is country-specific (refer to Appendix C for details). In the U. S. A., the default is two seconds. You can change this interval using the Dial Wait option.
K k < ,	Pause Delay	When any of these modifiers are encountered in a dial string or command line, the modem pauses. The factory default pause delay is three seconds. This default can be extended with the Pause Delay command. The comma modifier can be used as a command outside the dial string.
P p	Pulse	When either of these modifiers are encountered in a dial string, if Dial=Auto (AT*PT—DIALING OPTS menu), the Dial setting is not changed from Auto. If set to other than Auto, the pulse/tone setting is modified to force pulse dialing. If no pulse dial modifier is inserted in the number stream, the modem dials according to the pulse/tone setting of the Dial option in the front panel DIALING OPT'S menu. These modifiers can also be used as commands outside the dial string.
T t	Tone	When either of these modifiers are encountered in a dial string, if Dial=Auto (AT*PT—DIALING OPTS menu), the Dial option setting is not changed from Auto. If set to other than Auto, the pulse/tone setting is modified to force tone dialing. If no tone dial modifier is inserted in the number stream, the modem dials according to the pulse/tone setting or the Dial option in the front panel DIALING OPT'S menu. These modifiers can also be used as a command outside of the dial string.
& !	Flash	Instructs the modem to flash hook (a control signal used by many PBXs to enable special dial features, such as transferring a call).
;	Return to command state after dialing	Instructs the modem to return to command state after dialing, without breaking the connection. The modem can dial but cannot train, and no call progress messages are received. This modifier is used when calling an electronic service that permits the user to transmit numbers using tones, once a connection is established.

Table A-4.
Dial Modifiers (Continued)

Modifier	Function	Description
@	Quiet Answer	Makes the modem look for one or more ringbacks (followed by five seconds of silence) within the delay time specified by Call Timeout. If five seconds of delay silence is detected, the modem continues to dial the string. If the line is busy, the modem hangs up and sends a BUSY message to the DTE. If the modem does not detect delay silence or a busy signal, the modem hangs up and the screen displays NO ANSWER.
R	Reverse	Must be the last character in the dial string before a carriage return. The R modifier makes the modem originate the call in answer mode and is used to dial an originate-only modem. Immediately after the dial command is processed, an answer-back tone is generated and the modem attempts to complete the connection for the length of time specified by Call Time-out.
H h	Discon-nect	Makes the modem disconnect from the dial line. This must be the last modifier in the dial string, and must also be preceded by a semicolon. If this modifier is not preceded by a semicolon, it is ignored by the modem. The modifier can be entered through the front panel, the AT ACU, or network manager.
(space) . - () theses	Presen-tation characters	These characters do not act as modifiers. They are presentation characters that are ignored.

Result Codes

Result codes are responses sent to the terminal by the AT ACU. Result codes may be sent in word form (RsltForm=Verbose or ATV1), numeric form (RsltForm=Numeric or ATV0), or disabled (RsltCode=Disable or ATQ1). When numeric form is selected, the modem issues only a number code.

The rate displayed in a CONNECT message depends on the Connect Message option (ACU OPTS menu). If Con Msg=DTE Rate, the DTE-to-modem rate is displayed. If Con Msg=DCE Rate, the modem-to-modem rate is displayed. If Speed Conversion=Off (AT*SC0), or if the modem is operating in Direct or synchronous modes, the CONNECT message speed reflects both the DTE-to-modem and the modem-to-modem rate, which are the same.

Table A-5 provides a listing of word- and numeric-form result codes.

Table A-5.
Result Codes

<i>Word Form Response</i>	<i>Numeric Form Response</i>
OK	0
CONNECT	1
RING	2
NO CARRIER	3
ERROR	4
CONNECT 1200	5
NO DIALTONE	6
BUSY	7
NO ANSWER	8
PASSWORD PROTECTED	40
INITIATING RC	50
RC NOT AVAILABLE	51
RC FAILED	52
RC DENIED	53
RC ESTABLISHED	54
UNDER RMT CONFIG	55
RC COMPLETE	56
RC ABORTED	57
RC SESSION IN PROGRESS	58
NETWORK MANAGEMENT INHIBITED	60
CONNECT 600	13
CONNECT 2400	10
CONNECT 4800	11
CONNECT 7200	15
CONNECT 9600	12
CONNECT 12000	16
CONNECT 14400	17
CONNECT 16800	18
CONNECT 19200	14
CONNECT 21600	19

**Table A-5.
Result Codes (Continued)**

Word Form Response	Numeric Form Response
CONNECT 24000	20
CONNECT 26400	63
CONNECT 28800	64
CONNECT 31200	67
CONNECT 33600	68
CONNECT 38400	22
CONNECT 48000	61
CONNECT 56000	62
CONNECT 57600	23
CONNECT 64000	24
CONNECT 72000	26
CONNECT 76800	27
CONNECT 96000	28
CONNECT 115200	29
CONNECT 128000	65
CONNECT RELIABLE	21
CONNECT 600 RELIABLE	33
CONNECT 1200 RELIABLE	25
CONNECT 2400 RELIABLE	30
CONNECT 4800 RELIABLE	31
CONNECT 7200 RELIABLE	35
CONNECT 9600 RELIABLE	32
CONNECT 12000 RELIABLE	36
CONNECT 14400 RELIABLE	37
CONNECT 16800 RELIABLE	38
CONNECT 19200 RELIABLE	34
CONNECT 21600 RELIABLE	39
CONNECT 24000 RELIABLE	41
CONNECT 26400 RELIABLE	84
CONNECT 28800 RELIABLE	85
CONNECT 31200 RELIABLE	87
CONNECT 33600 RELIABLE	88
CONNECT 38400 RELIABLE	42
CONNECT 48000 RELIABLE	82
CONNECT 56000 RELIABLE	83
CONNECT 57600 RELIABLE	76
CONNECT 64000 RELIABLE	77
CONNECT 72000 RELIABLE	78
CONNECT 76800 RELIABLE	79
CONNECT 96000 RELIABLE	80
CONNECT 115200 RELIABLE	81
CONNECT 128000 RELIABLE	86
CONNECT RELIABLE EC=(xxx) DC=(yyy)	21
CONNECT 600 RELIABLE EC=(xxx) DC=(yyy)	33
CONNECT 1200 RELIABLE EC=(xxx) DC=(yyy)	25

**Table A-5.
Result Codes (Continued)**

Word Form Response	Numeric Form Response
CONNECT 2400 RELIABLE EC=(xxx) DC=(yyy)	30
CONNECT 4800 RELIABLE EC=(xxx) DC=(yyy)	31
CONNECT 7200 RELIABLE EC=(xxx) DC=(yyy)	35
CONNECT 9600 RELIABLE EC=(xxx) DC=(yyy)	32
CONNECT 12000 RELIABLE EC=(xxx) DC=(yyy)	36
CONNECT 14400 RELIABLE EC=(xxx) DC=(yyy)	37
CONNECT 16800 RELIABLE EC=(xxx) DC=(yyy)	38
CONNECT 19200 RELIABLE EC=(xxx) DC=(yyy)	34
CONNECT 21600 RELIABLE EC=(xxx) DC=(yyy)	39
CONNECT 24000 RELIABLE EC=(xxx) DC=(yyy)	41
CONNECT 26400 RELIABLE EC=(xxx) DC=(yyy)	84
CONNECT 28800 RELIABLE EC=(xxx) DC=(yyy)	85
CONNECT 31200 RELIABLE EC=(xxx) DC=(yyy)	87
CONNECT 33600 RELIABLE EC=(xxx) DC=(yyy)	88
CONNECT 38400 RELIABLE EC=(xxx) DC=(yyy)	42
CONNECT 48000 RELIABLE EC=(xxx) DC=(yyy)	82
CONNECT 56000 RELIABLE EC=(xxx) DC=(yyy)	83
CONNECT 57600 RELIABLE EC=(xxx) DC=(yyy)	76
CONNECT 64000 RELIABLE EC=(xxx) DC=(yyy)	77
CONNECT 72000 RELIABLE EC=(xxx) DC=(yyy)	78
CONNECT 76800 RELIABLE EC=(xxx) DC=(yyy)	79
CONNECT 96000 RELIABLE EC=(xxx) DC=(yyy)	80
CONNECT 115200 RELIABLE EC=(xxx) DC=(yyy)	81
CONNECT 128000 RELIABLE EC=(xxx) DC=(yyy)	86

NOTES:

- 1) When CONNECT messages are displayed, xxx indicates which error-correction scheme (LAPM or MNP 1-4) the modems are using, and yyy indicates which data compression scheme (V.42bis or MNP-5) the modems are using.
- 2) When a reliable connection has been established with the remote modem, the RELIABLE result code is displayed only when the Mode option (under the EC/DC OPT'S menu) is configured for Reliable (AT*SM2), Auto Rel (AT*SM3), or Spd AutoRel (AT*SM4). Also, the Rel Msg option (under the ACU OPT'S menu) must be set for Long (AT*XC2) or Short (AT*XC1).

Also, you receive error-correction and data-compression information in your result code only when the Rel Msg option is set to Long.

Configuring the Modem's Dual In-line Package (DIP) Switches

The standalone modem has a 6-position DIP switch that lets you “hard” configure certain aspects of the modem’s operation. The modem is shipped from the factory with all switches in the Off (up) position. DIP switch selections *cannot* be overridden using the remote front panel configuration.

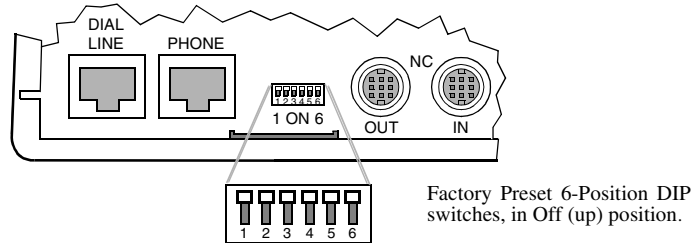

The switches are numbered from left to right (1 to 6). Table A-6 lists the switches and explains their function. **NOTE:** For information on the DIP switch on 3262, 3263, 3267, and 3268 Modem cards, see the addendum, *326X Series Modem Cards*, shipped with your modem’s backplane.

Table A-6.
Rear Panel Switches

Switch Number	Setting	Function
1	Off (up)	EIA/TIA 232-D Pin 23 is set for data rate input. Setting Switch 1 to this position has no effect on modem operation. NOTE: When operating with a V.35 electrical interface, leave switch S1 in the off (up) position at all times.
2	On (down)	EIA/TIA 232-D Pin 23 is set as a data indicator.
	Off (up)	Busy Out select. A signal on EIA/TIA 232-D Pin 25 makes the modem appear busy to incoming calls.
		NOTES:
		1) You must set DTE Pin 25=Busy (AT*LT, TERMINAL OPT’s category) to enable Busy Out Select.
		2) The AT&J Telco option command must be set to RJ4MB.
	On (down)	Test Indicator Signal (V.24 Circuit 142) Select. The modem signals to the terminal on EIA/TIA 232-D Pin 25 (V.24 Circuit 142) when a test is in progress.
		NOTES:
		1) You must set DTE Pin 25=Test (AT*LT, TERMINAL OPT’s category) to enable Busy Out Select.
		2) The AT&J Telco option command must be set to RJ4MB.

Table A-6.
Rear Panel Switches (Continued)

Switch Number	Setting	Function
3	Off (up)	Front panel enable. The front panel functions normally.
	On (down)	Front panel disable. You can check only the status displays. NOTE: If the modem is under remote configuration control, the controlling modem retains full front-panel control.
4	Off (up)	Normal password protection applies.
	On (down)	Reinitializes modem to its factory settings. Use this when you forget your password, to unlock password protection. (See Table A-1, under AT*PN.)
5	Off (up)	The AT and V.25bis, or LPDA-2 command sets can be used from an attached terminal.
	On (down)	AT and V.25bis commands cannot be used from an attached terminal. NOTE: If the modem is under remote configuration control, the controlling modem retains AT ACU control.
6	Off (up)	Factory use only. For proper operation, this switch must be off.

Appendix B

Cabling and Interface Pinouts

Contents

Introduction	B-2
EIA/TIA 232-D (Modem to Computer) Interface	B-2
ITU Recommendation V.35 Modem-to-Computer Interface	B-4
ITU Rate V.35 Modem-to-Computer Interface Pinouts	B-5
Differences, EIA/TIA 232-D and ITU Rate V.35 Interfaces	B-6
DIAL LINE, LEASE (PRIVATE) LINE, PHONE Connector Pinouts	B-6
NC (Network Control) Port Pinouts	B-7
Cabling	B-7
Cable Considerations	B-7
DTE Cable Diagnostics	B-10



Introduction

This appendix describes the following:

- **Interface pinouts** common to all modem models, including:
 - EIA/TIA 232-D, and ITU V.35 Recommendation modem-to-computer interfaces
 - NC IN and OUT network control port interfaces
- **326X/326X-SDC cabling requirements and diagnostics**

Audio connector (DIAL LINE, LEASE/PRIVATE LINE, and PHONE) pinouts vary by country. See Appendix C for your country's pinouts.

EIA/TIA 232-D (Modem to Computer) Interface

The modem's digital interface conforms to the EIA/TIA 232-D standard and ITU V.24, ITU V.28, and ISO 2110; the modem should be connected to a data terminal with a compatible digital interface (Table B-1). **NOTE:** For DTE rates greater than 38.4 kbps, refer to the "Cabling" section to determine cables and lengths.

Table B-1.
Modem/Computer Interface Connections

Pin	EIA/TIA		Signal	Definition
	232-D	ITU V.24		
1	—	—	—	Not used.
2	BA	103	Transmitted Data (TXD)	Digital data transmitted from the local terminal to the remote modem.
3	BB	104	Received Data (RXD)	Demodulated data received by the local terminal from the remote modem.
4	CA	105	Request To Send (RTS)	Sent from local terminal to local modem to ready it for data transmission.
5	CB	106	Clear To Send (CTS)	Passes from the local modem to the local terminal when the data port is clear to transmit data. Occurs in response to Request To Send.
6	CC	107	Data Set Ready (DSR)	Indicates the local modem is ready to transmit and receive data.
7	AB	102	Signal Ground	Common signal. Provides a common ground reference point for interface circuitry.
8	CF	109	Data Carrier Detect (DCD)	Passed from the local modem to the local DTE when an acceptable carrier signal is received by the modem.
9	—	—	—	Not Used.
10	—	—	—	Not Used.
11	—	—	Answer/ Originate Select	Signal passed from terminal to modem to select answer/originate status. When signal is on, answer signal is selected. When signal is off, originate signal is selected. This signal works with Mode=External .

Interface
Pinouts

**Table B-1.
Modem/Computer Interface Connections (Continued)**

Pin	EIA/TIA		Signal	Definition
	232-D	ITU V.24		
12	CI	112	Data Signal Rate Indicator	CI (112) is passed from modem to terminal, indicating signaling rate. When signal is on, modem operates at 2400 bps or greater. When signal is off, modem operates below 2400 bps.
13	—	110	Signal Quality	Signal passes from modem to terminal indicating signal quality of telephone line. When signal is on, signal quality is acceptable. When signal is off, signal quality is poor.
14	—	—	Ext Select	<i>(All models.)</i> Signal passed from terminal to modem to select between two option sets. Works in conjunction with Ext Select option. <i>(Models 3261/3263/3266/3268 only.)</i> Signal passed from terminal to modem indicating whether to use a dial line or a leased line. When signal is on, modem uses a dial line. When signal is off, modem uses a leased line. This signal is used in Restoral mode only.
15	DB	114	Transmitter Signal Element Timing	Local modem sends an internally generated transmit timing signal to local terminal to synchronize transmitted data (TXD). See Clock=Internal .
16	—	117	Standby Indicator	<i>(Models 3261/3263/3266/3268 only.)</i> Signal passed from modem to terminal indicating type of line in use. When signal is on, modem is on a dial line. When signal is off, modem is on a leased line. This signal is used in Restoral mode only.
17	DD	115	Receive Signal Element Timing	Timing signal extracted from the received carrier. Local modem transmits this signal to the DTE to synchronize received data (RXD).
18	—	141	Local Analog Loopback Test	Initiated at local terminal and passed to local modem, causing it to initiate local analog loopback test.
19	—	—	—	Not used.
20	CD	108.1/ 108.2	Data Terminal Ready (DTR)	108.1—Sent by DTE; causes the modem to connect to the phone line. 108.2—Sent by DTE; allows the modem to connect to the phone line.
21	—	140	Remote Digital Loopback Test	Signal initiated at local terminal and passed to local modem, causing it to initiate remote digital loopback test (V.54 Loop 2).
22	CE	125	Ring Indicator (RI)	Passed from local modem to local terminal. On during ringing, off between rings and when no ring received.
23	CH/CI	111/112	Data Signal Rate Select/Indicator	CI passed from modem to terminal indicating signaling rate. CI is set high for data rates greater than 2400 bps; otherwise, it is set low. CI is also set low while the modem is disconnected. The function of this pin is determined by the setting of rear panel Switch 1. CH (input) signal has no effect on modem operation.
24	DA	113	External Signal Element Timing	Transmit timing signal generated by some synchronous DTEs, providing clock to the local modem. See Clock=External setting.
25	—	142	Test Indicate (TI)	Local modem signals to local terminal when local modem is in test. The terminal can initiate a Busy Out condition on this circuit. The status of this signal is determined by the status of rear panel Switch 2 and front panel option DTE Pin 25 configured for Test or Busy.

Interface Pinouts

ITU Recommendation V.35 Modem-to-Computer Interface

For compatibility with DTEs operating with a V.35 interface, the 326XFAST-SDC Series Modem supports an optional ITU Recommendation V.35 Modem-to-Computer interface. Connection is made through the modem's DTE port (see Figure B-1).

NOTE: The 326XFAST-SDC Series Modem with a V.35 interface is currently available in the U. S. A. and Canada.



Caution

The 326XFAST-SDC Series Modem, if ordered with ITU's V.35 Recommendation, supports connection to external equipment also operating with a V.35 electrical interface. If your DTE does not have a V.35 interface, *do not, under any circumstances*, connect the modem to a non-V.35 device. If you make such a connection, you may seriously damage the modem. Telenetics makes no guarantee of the equipment's integrity if you do not ensure that compatible interfaces are used. If your DTE does not have a V.35 interface, use an external converter cable.

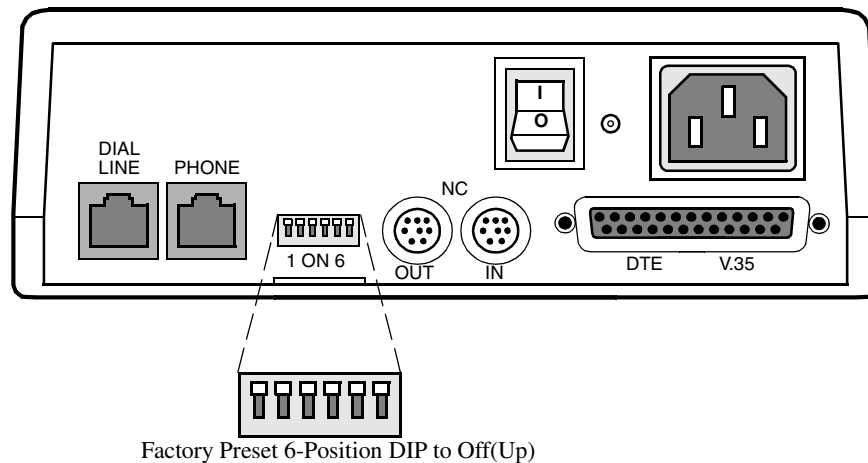

Figure B-1. 326XFAST-SDC Series Modem with ITU V.35 Interface

NOTES:

- 1) The modem is configured at the factory for an EIA/TIA 232-D interface *or* ITU rate V.35, and is shipped according to what you specify. Both interfaces are not available in the same unit.
- 2) When operating with the V.35 interface, switch S1 must be set to the off (up) position.

ITU Rate V.35 Modem-to-Computer Interface Pinouts

The modem's digital interface conforms to ITU Rate V.35. The modem should be connected to a data terminal with a compatible digital interface (see Table B-1).

Table B-2.
ITU V.35 Modem/Computer Interface Connections

Pin	V.35 Signal	Definition
1	Frame Ground	Frame (or protective) ground.
2	Transmit Data (A)	Digital data transmitted from the local terminal to the remote modem.
3	Receive Data (A)	Demodulated data received by the local terminal from the remote modem.
4	Request To Send (RTS)	Sent from local terminal to local modem to ready it for data transmission.
5	Clear To Send (CTS)	Passes from the local modem to the local terminal when the data port is clear to transmit data. Occurs in response to RTS.
6	Data Set Ready (DSR)	Indicates the local modem is ready to transmit and receive data.
7	Signal Ground	Common signal. Provides a common ground reference point for interface circuitry.
8	Data Carrier Detect (DCD)	Passed from the local modem to the local DTE when an acceptable carrier signal is received by the modem.
9	—	Not Used.
10	—	Not Used.
11	—	Not Used.
12	Receive Clock (B)	Timing signal extracted from the received carrier. Local modem transmits this signal to the DTE to synchronize received data.
13	Transmit Clock (B)	Local modem sends an internally generated transmit timing signal to the local terminal to synchronize transmitted data.
14	Transmit Data (B)	Digital data transmitted from the local terminal to the remote modem.
15	Transmit Clock (A)	Local modem sends an internally generated transmit timing signal to the local terminal to synchronize transmitted data.
16	Receive Data (B)	Demodulated data received by the local terminal from the remote modem.
17	Receive Clock (A)	Timing signal extracted from the received carrier. Local modem transmits this signal to the DTE to synchronize received data.
18	Loop 3 Control	Initiated at the local terminal and passed to local modem, causing it to initiate a local analog loopback test.
19	—	Not Used.
20	Data Terminal Ready (DTR)	108.1—Sent by the DTE, this signal causes connection of the modem to the phone line. 108.2—Sent by the DTE, this signal allows connection of the modem to the phone line.

Table B-2.
ITU V.35 Modem/Computer Interface Connections (Continued)

Pin	V.35 Signal	Definition
21	Loop 2 Control	Signal initiated at local terminal and passed to local modem, causing it to initiate remote digital loopback test (V.54 Loop 2).
22	Ring Indicator (RI)	Passed from local modem to local terminal. On during ringing, off between rings and when no ring received.
23	External Transmit Clock (B)	Transmit timing signal generated by some synchronous DTEs, providing clock to the local modem.
24	External Transmit Clock (A)	Transmit timing signal generated by some synchronous DTEs, providing clock to the local modem.
25	Test Indicate (TI)	Local modem signals to local terminal when local modem is in test. The terminal can initiate a Busy Out condition on this circuit.

Differences, EIA/TIA 232-D and ITU RateV.35 Interfaces

There are some differences in how your modem operates when using EIA/TIA 232-D and ITU Rate V.35 electrical interfaces. These differences, and settings to use when operating with a V.35 interface, are as follows.

When a V.35 Electrical Interface is Selected...	The Following Options Cannot Be Selected...	Set:
Pin 11 is not supported.	Mode=External (AT*CA2)	Mode= Originate (AT*CA0) Answer (AT*CA1), or Auto (AT*CA3)
Pin 12 is not supported	—NA—	—NA—
Pin 13 is not supported	—NA—	—NA—
Pin 14 is not supported	Ext Cntrl=Pin 14 (AT*OC0) Restore=FP/116 (AT*RE3) Restore=FP/116.ACU (AT*RE6)	Ext Cntrl=Pin 20 (AT*OC1—default). —NA—
Pin 16 is not supported	—NA—	—NA—
Pin 23 is not supported	—NA—	Switch S1 on modem rear panel to the Off (up) position.

DIAL LINE, LEASE (PRIVATE) LINE, PHONE Connector Pinouts

DIAL LINE, LEASE (PRIVATE) LINE, and PHONE connector pinouts vary by country. Consult Appendix C for your country's pinouts.

NC (Network Control) Port Pinouts

Table B-3 describes the pinouts for the IN and OUT NC (Network Control) ports.

Table B-3.
Network Control Port Connector Pinouts

<i>Pin</i>	<i>In</i>	<i>Out</i>
1	Not Connected	User Special In
2	TXD In	TXD Out
3	RXD In	RXD Out
4	RTS In	RTS Out
5	Not Connected	Not Connected
6	Not Connected	User Special Out
7	Ground	Ground
8	DCD In	DCD Out

“In” signals use a DCE-type interface. This type of interface connects directly to the DTE-type interface provided by Telenetics’ Network Management Systems.

“Out” signals use a DTE-type interface. This type of interface may connect to a Telenetics or Motorola network-managed product.

Cabling

This section provides important information about cabling and operating the modem at DTE rates greater than 19.2 kbps.

NOTE: 326XFAST and 326XFAST-SDC Series Modems are referred to as 326X Series Modems here.



Caution

When operating the modem at DTE rates higher than 19.2 kbps, *carefully* follow the information here to determine the cables to use with your application. For the modem to operate as specified, Telenetics has indicated the maximum capacitance of cables to be used when operating at data rates higher than 19.2 kbps. If this method is not followed, your modem may cause errors in data transmission. Telenetics makes no guarantee of proper modem operation if you do not use a cable with the correct capacitance.

Cable Considerations

Telenetics has specified a maximum allowable cable capacitance for use with the expanded data rates of 326X modems. You must determine the correct capacitance of the cable you intend to use with the modem.

Table B-4 shows a range of data rates and maximum allowable capacitances. The maximum capacitance is a total of the inter-conductor capacitance (between the conductors represented as Cc in Table B-4), and the capacitance between the shield and the conductor (represented as Cs in Table B-4).

Table B-4.
Maximum Cable Capacitance per Data Rate

Data Rate (kbps)	Maximum Cable Capacitance (Cc+Cs) in Pico Farads (pF)*
0-20.0	2400 pF
20.0-64.0	900 pF
64.0-96.0	400 pF
115.2	200 pF

Notes:

*(1) The total capacitance in this column is the total allowable cable capacitance.

(2) Maximum resistance of cable conductors is 25 Ohms.

The maximum allowable cable capacitance decreases as DTE rates increase. The more capacitance in the cable, the shorter the allowable length at a DTE rate. Similarly, the allowable lengths become shorter as DTE rates increase.

Since newer PCs support EIA 232-D type receivers/drivers at higher rates, you must use information in this section to determine cable length.

To determine the per foot capacitance of your cable:

- 1) Determine the length of the cable you require for your application.
- 2) Determine the range of rates that the modem will use. (For example, to routinely operate the modem's DTE port between 20.0 and 96.0 kbps, determine the cable capacitance for the higher rate. You can operate the modem up to, but not exceeding, the maximum rate capacitance that you calculate.)
- 3) Refer to Table B-4 for the maximum allowable cable capacitance for a given rate. (For example, to operate the modem at 64.0 kbps, the maximum capacitance is 900 pF.)
- 4) Divide the maximum cable capacitance by the length of the cable. This results in the total cable capacitance per foot. The formula below illustrates how to calculate the per-foot capacitance:

$$\frac{\text{Maximum Cable Capacitance (pF)}}{\text{Total Cable Length in Feet}} = \text{Maximum Cable Capacitance (pF) per Foot}$$

For example, assume you require a 30-foot cable. You intend to operate your modem at 64.0 kbps. After looking at Table B-4, you determine that the maximum capacitance for the cable is 900 pF. According to the formula above, divide 900 pF by 30 feet. The result is 30 pF per foot:

$$\frac{900 \text{ pF}}{30 \text{ ft}} = 30 \text{ pF/ft}$$

Telenetics recommends you use Telenetics cables to attach your 326X modem(s) to DTE(s). Use Table B-5 to select cable(s) for your application.

To use non-Telenetics cables, Table B-6 provides examples of vendor cable wire length versus DTE rates for 326X stand-alone units. **NOTE:** The part numbers specified in Table B-6 *are not* for complete cables, but for the wires that are available with the correct capacitance to support the higher rates of the 326X Modem.

Table B-5.
Telenetics DB-25 Low Capacitance Cables for 326X

Description	Telenetics Product Code	Up to 19.2 kbps (ft)	Up to 64.0 kbps (ft)	Up to 96.0 kbps (ft)	Up to 115.2 kbps (ft)
Telenetics Male 25-Male 25 Straight-through	92153 92152 92151 92150	50	30	10	6
Telenetics Male 25-Female 25 Straight-Through	92157 92156 92155 92154	50	30	10	6
Telenetics Male 25-Female 25 Crossover	92161 92160 92159 92158	50	30	10	6

NOTE: Telenetics DB-25 Cables have a conductor capacitance of 11 pF/ft and a shield capacitance of 20 pF/ft for a total capacitance of 31 pF/ft. For example, operating at 19.2 kbps, a 50-ft length of cable multiplied by a total capacitance of 31 pF/ft yields a maximum allowable cable capacitance of 1550pF, which is acceptable in accordance with Table B-4.



Table B-6.
Vendor Wire for 326X

Vendor	Part Number	Conductor Capacitance (pF)	Shield Capacitance (pF)	Up to 19.2 kbps (ft)	Up to 64.0 kbps (ft)	Up to 96.0 kbps (ft)	Up to 115.2 kbps (ft)
Belden	9948	35	63	24.49	9.18	4.08	2.04
	9671	30	55	28.24	10.59	4.71	2.35
	8125	12.5	22	69.57	26.09	11.59	5.80
	9937	12	22	70.59	26.47	11.76	5.88
	8155	11	20	77.42	29.03	12.90	6.45
Manhattan	M39026	33	65	24.49	9.18	4.08	2.04
	M13201	30	50	30	11.25	5.00	2.50
	M2414	26	47	32.88	12.33	5.48	2.74
	M3431	12.5	22	69.57	26.09	11.59	5.80
	M2434	12	22	70.59	26.47	11.76	5.88
Madison	25QF10BTI	14.6	26.3	58.68	22	9.78	4.89
	25QF15BTI	12.4	22.4	68.97	25.86	11.49	5.75

NOTE: To determine cable length, add the conductor and shield capacitance specified above to determine the total wire capacitance. For example, if you are using a Belden wire (Part Number 9671), add the conductor capacitance of 30 pF/ft and the shield capacitance of 55 pF/ft for a total capacitance of 85 pF/ft. If you are operating at a rate of 19.2 kbps, the maximum allowable cable length to attain throughput of 19.2 kbps is 28.24 feet. Multiplying 28.24 by the total cable capacitance of 85 pF/ft yields a maximum allowable cable capacitance of 2410.4 pF, which is acceptable in accordance with Table B-4.

DTE Cable Diagnostics

This section helps determine whether there is a problem with a DTE cable. Perform the following steps *before* continuing with installation. If you continue to experience problems with data transmission after choosing a cable and running the diagnostics in this section, the problem may be with your DTE or modem.

If the modem *is not installed at a host site*, perform the following steps:

- 1) Enable the AT ACU (if not already enabled) with async echo on (reinitializing the modem will also enable the AT ACU with async echo set to on). Ensure that rate and parity of the modem and the DTE are identical.
- 2) Send data to the modem from the DTE. **NOTE:** Do not substitute test equipment for the DTE, as the DTE's receivers/drivers are used in this test.
- 3) If echoed data from the modem (as received by the DTE) matches the transmitted message, send the status screen (AT*ST<CR>) command.
- 4) If there are no errors in either of the previous tests, the cable is appropriate for your application.

- 5) If the transmitted and received messages are different (i.e., character or framing errors), verify the cable length to the limit specified in Table B-4. Reduce the cable length or capacitance of the cable to the theoretical limit and retry the steps listed in this section. (If the same cable length is required, it is recommended that a low capacitance type cable be used.)

If the modem *is installed at a host site*, perform the following steps:

- 1) Set the Mode option AT*SM (EC/DC OPT'S category) to Reliable. (Reliable mode ensures data is transmitted during this test.) **NOTE:** Do not initiate loop tests while performing the diagnostic procedures in this section.
- 2) Follow Steps 1 to 3 in the section above to verify the cable at a remote site.
- 3) Once the cable at the remote site has been verified, initiate a dial connection with the host site.
- 4) If there are no errors in data transmission, the cable at the host site is most likely appropriate for the application.
- 5) If the transmitted and received messages are different, the cable at the host site is most likely incorrect for the application. Verify the cable length to the limit specified in Table B-4. Reduce the cable length or capacitance of the cable to the theoretical limit and retry Steps 1 to 3 in the section above. (If the same cable length is required, it is recommended that a low capacitance type cable be used.)

NOTE: These tests should be done prior to a Local Analog Loopback (LAL) or Remote Digital Loopback (RDL) test when troubleshooting.



Appendix C

Country-Specific Information

Contents

Introduction	C-3
Country Support	C-3
Installation Notes	C-4
Restricted Features Summary	C-5
Operating Notes	C-12
Standalone Modem Rear Panel Views	C-12
3260 Dial Only Modem	C-13
3261 Modem Rear View (Leased Line, Dial Restoral)	C-13
3265 Dial Only Modem	C-14
3266 Modem (Leased Line with Dial Restoral)	C-16
Rear Panel Interface Pinouts	C-18
Standalone Models 3260/65 and 3261/66 Interface Pinouts	C-18
Card Models 3262/67, 3263/68 Backplane Interface Pinouts	C-21
Delayed and Forbidden Lists	C-23
Australia—Delayed Call Lists	C-23
Austria—Forbidden Call Lists	C-24
Belgium—Delayed Call Lists	C-24
Finland—Delayed Call Lists	C-25
France—Delayed and Forbidden Call Lists	C-25
Hong Kong—Delayed Call Lists	C-26
Ireland—Delayed Call Lists	C-26
Netherlands—Delayed Call Lists	C-27
Norway—Delayed Call Lists	C-27
Spain—Delayed Call Lists	C-28
Other Country-Specific Information	C-28
Canada	C-28
DOC Registration and Requirements	C-28
Industry Canada Equipment Attachment Limitations	C-29
Canadian Emissions Statement	C-29
Rear Panel Pinouts	C-30
Telco Option (AT&J)	C-31
Denmark—Blind Dialing	C-32
Hong Kong and United Kingdom—BABT Regulations	C-32
Compliance with BS6328: Part 1: 1982 Section 8.3	C-32
Compliance with BS6328: Part 1: 1982 Section 8.7	C-32
Compliance with BABTSITS/82/01/C and BABT/SITS/82005S/D	C-33
Compliance with BS6305 Clause 6.2, BS6320 Clause 7.2	C-33
Ringer Equivalence Number (REN)	C-33
Compliance with BABT/SITS/83/08/A Clause 1.2	C-34
Compliance with BS6789: Section 6.1:1986 Clause 5.2	C-34
Compliance with BS6789: Section 6.1:1986 Clause 7.3.1.3	C-34
Compliance with BS6789: Section 6.1:1986 Clause 7.3.1.4	C-34
Compliance with DTI 83/009I	C-35
Compliance with BS6301	C-35
Compliance with BABT SITS 83/009 Section D	C-35

Contents (Continued)

Installation of Telephone Socket C-36
Application for Installation of Telephone Socket C-36
U. S. A. C-36
 FCC Registration C-36
 FCC Regulations C-37
 Dial Line Jack Types C-38
 Rear Panel Pinouts C-39
 Dial and Leased Line Transmit Levels C-41
 Making Telephone-to-Modem Connections C-41
 Telco Option (AT&J) C-42
Declaring The Jack Type C-42
Using the Modular Nest Backplane’s Busy Out Feature C-43

Introduction

This appendix provides information for operating the modem, by country, including:

- **Restricted features summary**, describing modem features that are restricted or limited by regulatory agencies in some countries
- **Installation Notes**, containing information useful when installing the modem in countries other than the U. S. A. and Canada
- **Modem standalone rear panel views**, and the countries supporting each view
- **Modem rear panel interface pinouts**
- **Cables shipped to each country along with pinouts**
- **Delayed/Forbidden list** operation in each country
- **Country-specific information** that applies only to: Canada, Denmark, Hong Kong, the United Kingdom and the U. S. A.

Use the Universal International section if your country *is not* one of the following:

Australia	France	Japan	Spain
Belgium	Germany	Malaysia	Sweden
Canada	Hong Kong	Netherlands	Switzerland
Czech Republic	Ireland	Norway	United Kingdom
Denmark	Israel	Portugal	U. S. A.
Finland	Italy	South Africa	

NOTE: References to the 326X Series Modem apply to 326XV.32bis, 326X, and 326X-SDC Series Modems, unless stated otherwise.

Country Support

Country approval is an ongoing process. If you have questions about approval and availability in your country, contact a Telenetics sales representative or distributor.

Installation Notes

This section provides information useful when installing the modem in countries *other than the U. S. A. and Canada.*

Models 3265/3266



Warning

Ports that are capable of connecting to other apparatus are defined as SELV. To ensure conformity with EN60950 - ensure that these ports are only connected to ports of the same type on other apparatus.



Avertissement

Les ports qui sont susceptibles d'être connectés à des équipements sont désignés comme TBTS. Pour garantir la conformité à la norme EN 60950, n'interconnecte ces ports qu'avec des ports du même type sur des autres matériels.



Warnung

Anschlüsse, die mit anderen Geräten verbindet werden können, sind als SELV beschrieben. Um Konformität mit EN 60950 zu versichern, sichern Sie es, daß diese Anschlüsse nur mit den des selben Type auf anderen Geräten verbindet werden.

All Models

These units are not suitable for connection to an IT power distribution system, nor for use in a host device which is connected to an IT power distribution system.

Restricted Features Summary

This section summarizes restricted features, by country, as follows:

- If an entry is blank, the feature is unrestricted.
- If an entry reads “Restricted,” the feature is not allowed.
- If the entry says that a feature is Always=*x*, the feature is enabled and cannot be changed by the user. *X* is also the default option.
- If the entry shows front panel settings and AT command settings, only the listed settings are allowed. (Settings not listed are restricted.)

In the following example, **Answer** can be set only to Manual (AT*AA0), Ring #1 (AT*AA1), and Ring #2 (AT*AA2). Other settings are restricted.

Setting	AT Command
Manual	AT*AA0
Ring #1	AT*AA1
Ring #2	AT*AA2

NOTE: Refer to later sections in this appendix for information on using the modem in the U. S. A.

Feature	Australia	Austria	Belgium	Canada
ATH Test	Test=Busy Out (ATH1) Restricted in 3265/6	Test=Busy Out (ATH1) Restricted in all models		Test=Busy Out (ATH1) Restricted in 3268
ATX Call Progress			Always=4, ATX4	
AT&D7 108.2/Bsy		Restricted		
AT&G Guard Tone	Always=1800 (AT&G1) in 3265/67 550 AT&G1 1800 AT&G2 in: 3266/8	550 AT&G1 1800 AT&G2 in 3266/8		
AT&J Telco	Restricted	Restricted	Restricted	
AT&P Pulse Cycle	Always=33%, AT&P1	Always=40%, AT&P0	Always=33%, AT&P1	
AT*AA Answer	Manual AT*AA0 Ring #2 AT*AA2	Manual AT*AA0 Ring #1 AT*AA1 Ring #2 AT*AA2	Manual AT*AA0 Ring #1 AT*AA1 Ring #2 AT*AA2	
AT*BD Blind Dial	Always=4 sec AT*BD1	Always=4 sec AT*BD1	Restricted	
AT*CD Loss Dis		7 sec AT*CD2 3 sec AT*CD1		
AT*DD Dial Wait	Always=6 sec AT*DD3	6 sec AT*DD3 4 sec AT*DD2 3 sec AT*DD1	Always=20 sec AT*DD6	2 sec AT*DD0 4 sec AT*DD2 6 sec AT*DD3 S7 AT*DD9
AT*DP Pause Delay	Always=4 sec			
AT*DR Auto Redial	Off AT*DR0 1 AT*DR1 2 AT*DR2 3 AT*DR3	Off AT*DR0 1 AT*DR1 2 AT*DR2 ... 8 AT*DR8	Off AT*DR0 1 AT*DR1 2 AT*DR2 3 AT*DR3	
AT*LL LAL Busy Out	Restricted in 3265/6	Restricted		Restricted in 3268
AT*LN DTE Pin 25	Restricted in 3265/6	Restricted		Restricted in 3268
AT*TL Tone Length	Always=72 ms AT*TL0	Always=72 ms AT*TL0	Always=72 ms AT*TL0	
AT*TT Call Timeout	30 sec AT*TT0 60 sec AT*TT2	30 sec AT*TT0 60 sec AT*TT2	30 sec AT*TT0 60 sec AT*TT2	30 sec AT*TT0 45 sec AT*TT1
DL TX Level	Always=-10dBm	Always=-9dBm	Always=-6dBm	Not supported. Select dial line transmit level using Telco option (TELCO OPTS menu)
LL TX Level	Always=-13dBm	Always=-9dBm	Always=-6dBm	Set to 0dBm; adjustable from 0 to -15 dBm

Feature	Czech Republic and Poland	Denmark	Finland	France
ATH Test	Test=Busy Out (ATH1) Restricted in all models	Test=Busy Out (ATH1) Restricted in Rel. 4.0 & earlier; not restricted in Rel. 4.1 & later		Test=Busy Out (ATH1) Restricted in all models
ATX Call Progress		Always=4, ATX4		Always=4, ATX4
AT&D7 108.2/Bsy				Restricted
AT&G Guard Tone				AT&G0 550 AT&G1 1800 AT&G2
AT&J Telco	Restricted	Restricted	Restricted	
AT&P Pulse Cycle		Always=33% AT&P1	Always=40% AT&P0	Restricted
AT*AA Answer		Manual AT*AA0 Ring #1 AT*AA1 Ring #2 AT*AA2 Using S0 AT*AA5	Manual AT*AA0 Ring #2 AT*AA2 Using S0 AT*AA5	Always=33% AT&P1
AT*BD Blind Dial		2sec AT*BD0 4sec AT*BD1		Manual AT*AA0 Ring #2 AT*AA2
AT*CD Loss Dis				Restricted
AT*DD Dial Wait	2 sec AT*DD1 4 sec AT*DD2 6 sec AT*DD3 Using S7 AT*DD9	2 sec AT*DD0 4 sec AT*DD2 6 sec AT*DD3 15 sec AT*DD5 20 sec AT*DD6	4 sec AT*DD2 6 sec AT*DD3 15 sec AT*DD5 Using S7 AT*DD9	Off AT*CD0 3 sec AT*CD1
AT*DP Pause Delay		Always=3 sec		6 sec AT*DD3 12 sec AT*DD4
AT*DR Auto Redial	Off AT*DR0 1 AT*DR1 2 AT*DR2 ... 8 AT*DR8		Off AT*DR0 1 AT*DR1 2 AT*DR2 ... 8 AT*DR8	3 sec AT*DP0 6 sec AT*DP1 9 sec AT*DP2 12 sec AT*DP3
AT*LL LAL Busy Out	Restricted			Restricted
AT*LN DTE Pin 25	Restricted			Restricted
AT*TL Tone Length	Always=72 ms AT*TL0	Always=72 ms AT*TL0	Always=72 ms AT*TL0	Always=72 ms AT*TL0
AT*TT Call Timeout	30 sec AT*TT0 60sec AT*TT3 90 sec AT*TT2 Using S7 AT*TT5	30 sec AT*TT0 60 sec AT*TT2	30 sec AT*TT0 60 sec AT*TT3 90 sec AT*TT2 Using S7 AT*TT5	45 sec AT*TT1 60 sec AT*TT2
DL TX Level	Always=-9 dBm	Always=-11dBm	Always=-11 dBm	Always=-10dBm
LL TX Level	Always=0 dBm	Always=-11dBm	Always=-11 dBm	Always=-13dBm

Feature	Germany	Hong Kong	Ireland	Israel
ATH Test	Test=Busy Out (ATH1) Restricted all models†		Test=Busy Out (ATH1) Restricted in 3265/6	
ATX Call Progress				
AT&D7 108.2/Bsy	Restricted			
AT&G Guard Tone			550 AT&G1 1800 AT&G2 in: 3265/7 Always=1800 (AT&G2) in 3266/8	
AT&J Telco	Restricted	Restricted	Restricted	Restricted
AT&P Pulse Cycle	Always=40% AT&P0	Always=33% AT&P1	Always=33% AT&P1	Always=40% AT&P0
AT*AA Answer	Manual AT*AA0 Ring #1 AT*AA1 Ring #2 AT*AA2 Ring #4 AT*AA4	Manual AT*AA0 Ring #2 AT*AA2	Manual AT*AA0 Ring #1 AT*AA1 Ring #2 AT*AA2	Manual AT*AA0 Ring #2 AT*AA2
AT*BD Blind Dial	2 sec AT*BD0 4 sec AT*BD1			
AT*CD Loss Dis	Off AT*CD0 3 sec AT*CD1 7 sec AT*CD2			
AT*DD Dial Wait	2 sec AT*DD0 4 sec AT*DD2 6 sec AT*DD3 15 sec AT*DD5 20 sec AT*DD6	Always=6 sec AT*DD3	3 sec AT*DD1 4 sec AT*DD2 6 sec AT*DD3	2 sec AT*DD1 4 sec AT*DD2 6 sec AT*DD3 Using S7 AT*DD9
AT*DP Pause Delay				
AT*DR Auto Redial		Off AT*DR0 1 AT*DR1 2 AT*DR2 3 AT*DR3	Off AT*DR0 1 AT*DR1 2 AT*DR2 3 AT*DR3	
AT*LL LAL Busy Out	Restricted		Restricted in 3265/6	
AT*LN DTE Pin 25	Restricted	Restricted in 3265/6/8	Restricted in 3265/6	
AT*TL Tone Length	Always=72 ms AT*TL0	Always=72 ms AT*TL0	Always=72 ms AT*TL0	Always=72 ms AT*TL0
AT*TT Call Timeout	30 sec AT*TT0 60 sec AT*TT2	30 sec AT*TT0 60 sec AT*TT2 90 sec AT*TT3 180 sec AT*TT4	30 sec AT*TT0 60 sec AT*TT2	30 sec AT*TT0 60 sec AT*TT3 90 sec AT*TT2 Using S7 AT*TT5
DL TX Level	Always=-10dBm	Always=-9dBm	Always=-8dBm	Always=-9 dBm
LL TX Level	Always=-6dBm	Always=-11dBm	Always=-12dBm	Always=0 dBm
† NOTE: If you issue the ATD command without an attached telephone number, the modem responds: ERROR.				

Feature	Italy	Japan	Malaysia	Netherlands				
ATH Test			Test=Busy Out (ATH1) Restricted all models					
ATX Call Progress				Always=4 ATX4				
AT&D7 108.2/Bsy			Restricted					
AT&G Guard Tone		Restricted						
AT&J Telco	Restricted	Restricted	Restricted	Restricted				
AT&P Pulse Cycle	Always=38% AT&P2	Always=33% AT&P1	Always=33% AT&P1	Always=38% AT&P2				
AT*AA Answer	Manual Ring #2 Ring #4	AT*AA0 AT*AA2 AT*AA4						
AT*BD Blind Dial	4 Sec Using S6	AT*BD1 AT*BD2	Always=4 sec AT*BD1	Restricted				
AT*CD Loss Dis								
AT*DD Dial Wait	4 sec 6 sec 15 sec Using S7	AT*DD2 AT*DD3 AT*DD5 AT*DD9	3 sec 4 sec 6 sec	AT*DD1 AT*DD2 AT*DD3	2 sec 4 sec 6 sec Using S7	AT*DD1 AT*DD2 AT*DD3 AT*DD9	15 sec 30 sec 40 sec	AT*DD5 AT*DD7 AT*DD8
AT*DP Pause Delay				Always=3 sec				
AT*DR Auto Redial	Off 1 2 3 4	AT*DR0 AT*DR1 AT*DR2 AT*DR3 AT*DR4	Off 1 2	AT*DR0 AT*DR1 AT*DR2	Off 1 ... 8	AT*DR0 AT*DR1 ... AT*DR8		
AT*LL LAL Busy Out				Restricted				
AT*LN DTE Pin 25				Restricted				
AT*TL Tone Length	Always=72 ms AT*TL0	Always=72 ms AT*TL0	Always=72 ms AT*TL0	Always=72 ms AT*TL0				
AT*TT Call Timeout	30 sec Using S7	AT*TT0 AT*TT5	30 sec 45 sec	AT*TT0 AT*TT1	30 sec 60 sec 90 sec Using S7	AT*TT0 AT*TT3 AT*TT2 AT*TT5		
AT*PT Dial					Dial=Auto Restricted			
DL TX Level	Always=-9 dBm	Set to -15dBm; adjustable from 0 to -15 dBm	Always=-9 dBm	Always=-6dBm				
LL TX Level	Always=-13 dBm	Set to 0dBm; adjustable from 0 to -15 dBm	Always=0 dBm	Always=-6dBm				

Feature	Norway	Portugal	South Africa	Spain
ATH Test		Test=Busy Out (ATH1) Restricted in all models		Test=Busy Out (ATH1) Restricted in all models
ATX Call Progress				Always=4, ATX4
AT&D7 108.2/Bsy		Restricted		Restricted
AT&G Guard Tone	Restricted		Always=1800 (AT&G1) Models 3265/7 550 AT&G1 1800 AT&G2 in: 3266/8	
AT&J Telco	Restricted	Restricted	Restricted	Restricted
AT&P Pulse Cycle	Always=40%, AT&P0	Always=33%, AT&P1	Always=33%, AT&P1	Always=33%, AT&P1
AT*AA Answer	Manual AT*AA0 Ring #1 AT*AA1 Ring #2 AT*AA2 Using S0 AT*AA5			Manual AT*AA0 Ring #2 AT*AA2
AT*BD Blind Dial	Restricted		Always=4 sec AT*BD1	Restricted
AT*CD Loss Dis	Off AT*CD0 3 sec AT*CD1 7 sec AT*CD2			3 sec AT*CD1 7 sec AT*CD2
AT*DD Dial Wait	2 sec AT*DD0 4 sec AT*DD2 6 sec AT*DD3 15 sec AT*DD5 20 sec AT*DD6	2 sec AT*DD0 4 sec AT*DD2 6 sec AT*DD3 Using S7 AT*DD9	Always=6 sec AT*DD3	3 sec AT*DD1 4 sec AT*DD2 6 sec AT*DD3
AT*DP Pause Delay			Always=4 sec	
AT*DR Auto Redial			Off AT*DR0 1 AT*DR1 2 AT*DR2 3 AT*DR3	Off AT*DR0 1 AT*DR1 2 AT*DR2 3 AT*DR3 4 AT*DR4
AT*LL LAL Busy Out		Restricted		Restricted
AT*LN DTE Pin 25		Restricted		Restricted
AT*TL Tone Length	Always=72 ms AT*TL0	Always=72 ms AT*TL0	Always=72 ms AT*TL0	Always=72 ms AT*TL0
AT*TT Call Timeout	30 sec AT*TT0 60 sec AT*TT2		30 sec AT*TT0 60 sec AT*TT2	30 sec AT*TT0 60 sec AT*TT2
DL TX Level	Always=-10dBm	Always=-9dBm	Always=-9 dBm	Always=-11 dBm
LL TX Level	Always=-10dBm	Always=0dBm	Always=-13 dBm	Always=-6dBm

Feature	Sweden	Switzerland	United Kingdom	Universal
ATH Test		Test=Busy Out (ATH1) Restricted in Rel. 4.0 and earlier; not restricted in Rel. 4.1 and later		Test=Busy Out (ATH1) Restricted
ATX Call Progress	Always=4 ATX4	Always=4 (ATX4)		
AT&D7 108.2/Bsy				
AT&G Guard Tone			550 AT&G1 1800 AT&G2 in: 3265/7 Always=1800 (AT&G2) in 3266/8	
AT&J Telco	Restricted	Restricted	Restricted	Restricted
AT&P Pulse Cycle	Always=40% AT&P0		Always=33% AT&P1	
AT*AA Answer		Manual AT*AA0 Ring #2 AT*AA2		
AT*BD Blind Dial	Restricted		Always=4 sec AT*BD1	
AT*CD Loss Dis				
AT*DD Dial Wait	15 sec AT*DD5 30 sec AT*DD7 40 sec AT*DD8	6 sec AT*DD3 12 sec AT*DD4	Always=6 seconds AT*DD3	2 sec AT*DD0 4 sec AT*DD2 6 sec AT*DD3 S7 AT*DD9
AT*DP Pause Delay		Always=3 sec	Always=4 sec	
AT*DR Auto Redial			Off AT*DR0 1 AT*DR1 2 AT*DR2 3 AT*DR3	
AT*LL LAL Busy Out				Restricted
AT*LN DTE Pin 25				Restricted
AT*TL Tone Length	Always=72 ms AT*TL0	Always=72 ms AT*TL0	Always=72 ms AT*TL0	Always=72 ms AT*TL0
AT*TT Call Timeout	30 sec AT*TT0 60 sec AT*TT2	30 sec AT*TT0 60 sec AT*TT2	30 sec AT*TT0 60 sec AT*TT2	
DL TX Level	Always=-13dBm	Always=-9dBm	Always=-9dBm	Set to -9dBm; adjustable from 0 to -15 dBm
LL TX Level	Always=-13dBm	Always=-6dBm	Always=-13dBm	Set to 0dBm; adjustable from 0 to -15 dBm

Operating Notes

This section summarizes useful operating information.

- Restricted front panel option settings do not appear in front panel menus
- PC software communication packages often send fixed initialization strings to the modem (via AT commands). These strings do not account for country-specific modem restrictions.

To make software communication package installation easier, the modem responds as follows:

- If you enter a restricted AT, AT*, or AT& command for an option that is completely restricted, the modem displays OK instead of ERROR. The modem, does *not*, however, modify its configuration in this case.

IMPORTANT: *The command does not change the modem configuration. An OK lets the software package continue communication with the modem. Some software packages may be affected by this new functionality. Telenetics recommends that you change the initialization string of your software communication package for the restricted options or option settings that may apply in your country. Refer to the software package documentation for further information.*

- If you enter a restricted AT, AT*, or AT& command for an option that has some restricted settings, the modem displays ERROR
- If you enter a restricted V.25 bis command, the modem responds with the INValid message, INV

Standalone Modem Rear Panel Views

This section shows rear panel views for models 3260, 3261, 3265, and 3266. Following each illustration is a list of the countries that use that modem version.

NOTE: For Models 3262, 3263, 3267 and 3268, the addendum, *326X Series Modem Cards* (shipped with the modem backplane), contains enclosure card and backplane information.

3260 Dial Only Modem

3260 Modem Rear Panel (Dial Only)

Figure C-1 shows the rear panel of the 3260 dial only modem. This version is used in:

- U. S. A. (Model 3260)
- Canada (Model 3265)
- Japan (Model 3265)

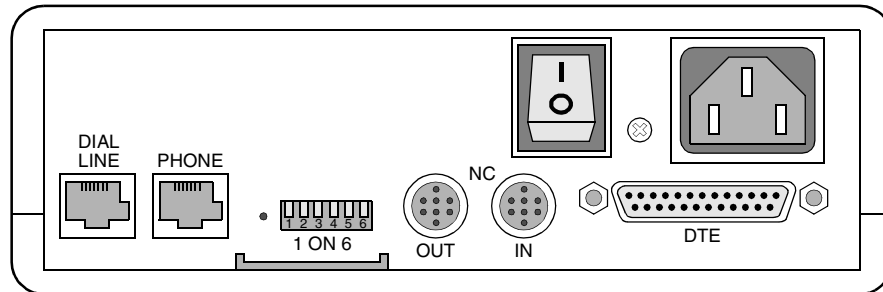

Figure C-1. Rear Panel Layout - 3260 (Dial Only)

3261 Modem Rear View (Leased Line, Dial Restoral)

Figure C-2 shows the rear panel view of the 3261 leased line modem with dial restoral. This version is used in:

- U. S. A. (Model 3261)
- Canada (Model 3266)
- Japan (Model 3266)

NOTE: 326X Series Modems for Canada and Japan are identical to Model 3261 for the U. S. A. The model number of the modem for Canada and Japan is 3266. Canada and Japan are included in this section with the view of the U.S.A. 3261 modem.

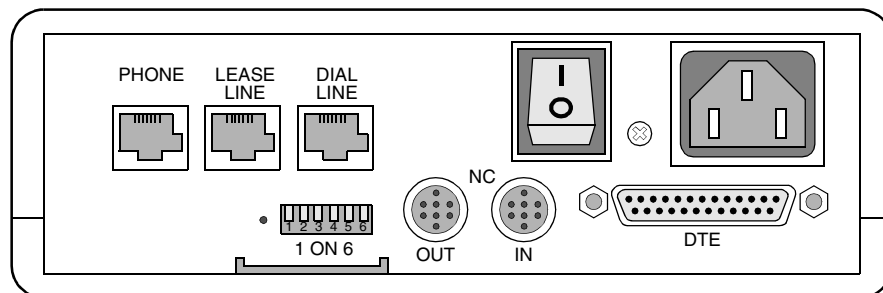

Figure C-2. Rear Panel Layout - 3261 (Leased Line with Dial Restoral)

3265 Dial Only Modem

This section shows rear panel views of the 3265 dial only modem, and the countries using the layout.

3265 Modem Rear Panel—View A

Figure C-3 shows View A of the 3265 Modem. This version is used in:

- Australia
- Belgium
- Czech Republic
- Denmark
- Finland
- Ireland
- Israel
- Italy
- Malaysia
- Netherlands
- Norway
- Portugal
- South Africa
- Spain
- Universal International

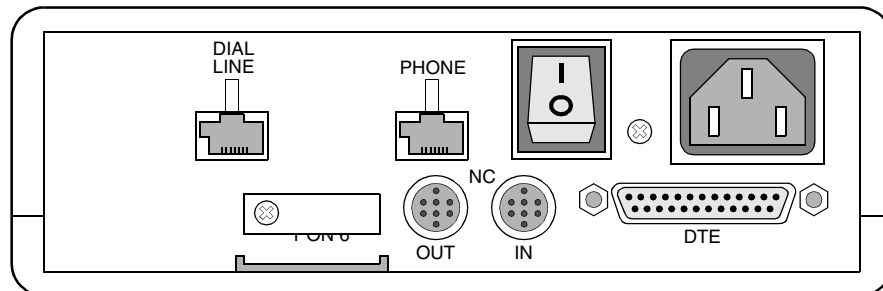

Figure C-3. View A Rear Panel Layout - 3265 (Dial Only)

3265 Modem Rear Panel—View B

Figure C-4 shows View B of the 3265 Modem. This version is used in Germany and Austria.

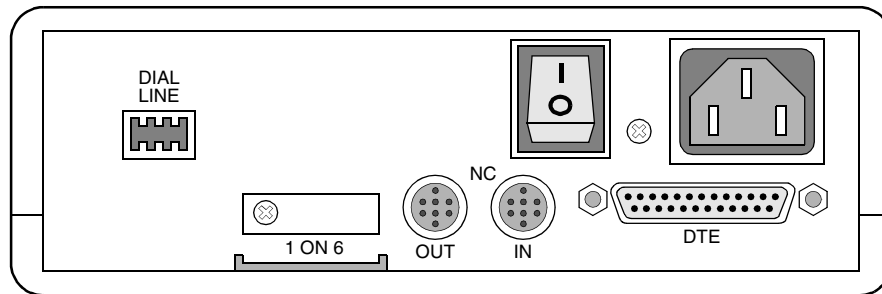

Figure C-4. View B Rear Panel Layout - 3265 (Dial Only)

3265 Modem Rear Panel—View C

Figure C-5 shows View C of the 3265 Modem. This version is used in Hong Kong and the United Kingdom.

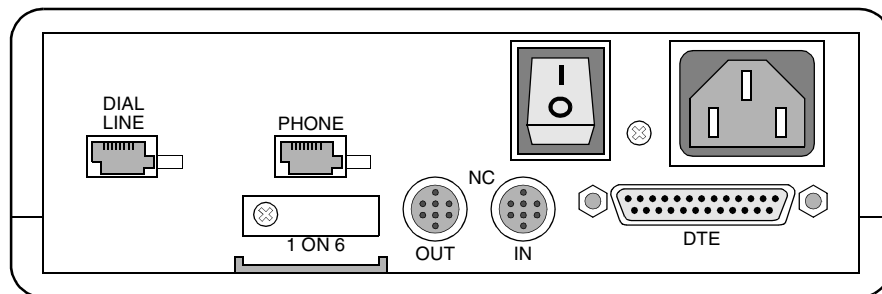

Figure C-5. View C Rear Panel Layout - 3265 (Dial Only)

3265 Modem Rear Panel—View D

Figure C-6 shows View D of the 3265 Modem. This version is used in France, Sweden, and Switzerland.

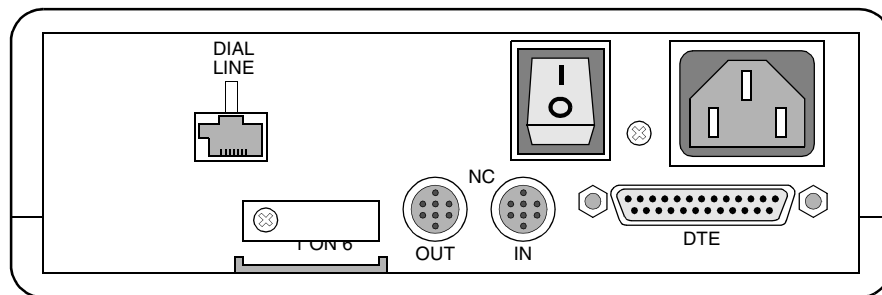

Figure C-6. View D Rear Panel Layout - 3265 (Dial Only)

3266 Modem (Leased Line with Dial Restoration)

This section shows three rear panel views of the 3266 leased line modem with dial restoration, and the countries using the layout.

3266 Modem Rear Panel—View A

Figure C-7 shows View A of the 3266 Modem. This version is used in:

- Australia
- Belgium
- Czech Republic
- Denmark
- Finland
- France
- Ireland
- Israel
- Italy
- Malaysia
- Netherlands
- Norway
- Portugal
- South Africa
- Spain
- Sweden
- Switzerland
- Universal International

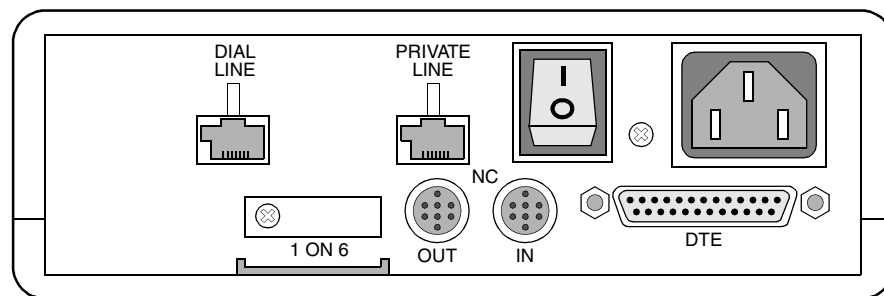

Figure C-7. View A Rear Panel Layout - 3266 (Leased Line with Dial Restoration)

3266 Modem Rear Panel—View B

Figure C-8 shows View B of the 3266 Modem. This version is used in Germany and Austria.

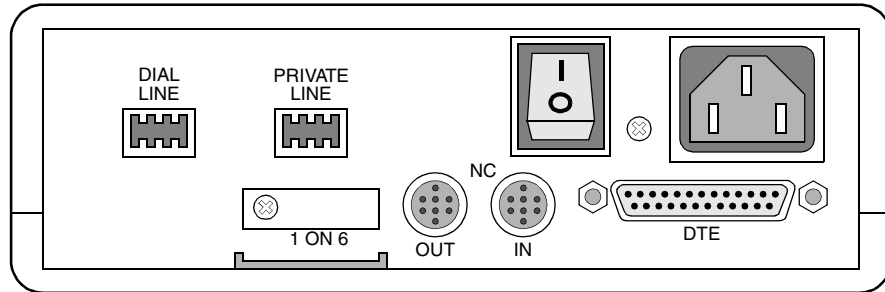

Figure C-8. View B Rear Panel Layout - 3266 (Leased Line with Dial Restoral)

3266 Modem Rear Panel—View C

Figure C-9 shows View C of the 3266 Modem. This version is used in Hong Kong and the United Kingdom.

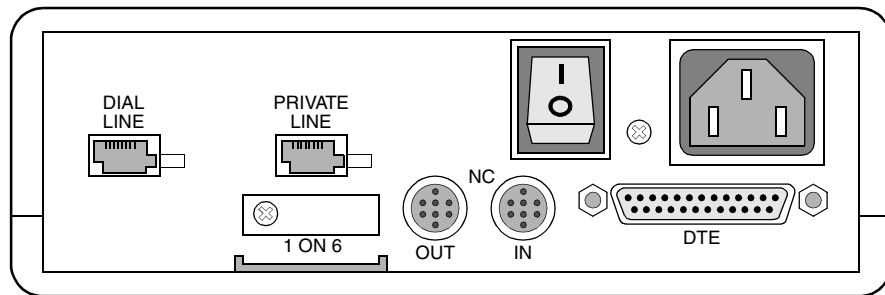

Figure C-9. View C Rear Panel Layout - 3266 (Leased Line with Dial Restoral)

For an Illustration of the Enclosure Card Backplane...

Refer to the addendum, *326X Series Modem Cards*, shipped with the backplane.

Rear Panel Interface Pinouts

This section shows the rear panel interface pinouts for the modem *stand-alone* models 3260, 3261, 3265, and 3266, and *enclosure card* models 3262, 3263, 3267, and 3268.

Standalone Models 3260/65 and 3261/66 Interface Pinouts

This section shows the pinouts for the standalone modem's rear panel connectors.

Dial Line Interface (Models 3260/3265)

Dial line connection is made via the DIAL LINE interface on the modem's rear panel. Table C-1 describes DIAL LINE connector pinouts.

Table C-1.
Dial Line Interface (Models 3260/3265)

Dial Line Connector Pin	Canada/ U. S. A.*	Hong Kong/ United Kingdom	Germany/ Austria	All Other Countries
1	MB	Not Used	LA	Not Used
2	MB1	Telset B	Not Used	Not Used
3	MI	Bell Shunt	Ring Indicator	Telset Ring
4	Ring	Not Used	LB	Ring
5	Tip	Telset A	b2	Tip
6	MIC	Not Used	Not Used	Telset Tip
7	PR		Not Used	Not Used
8	PC		a2	Not Used

*Refer to Canada/U. S. A. country-specific sections for rear panel pinouts cross-referenced with telco jack selections.

2-Wire Leased Line Interface (Models 3260/3265)

2-wire leased line connections are made via the DIAL LINE interface on the rear panel. Table C-2 describes 2-wire leased line interface pinouts.

Table C-2.
2-Wire Leased Line Interface (Models 3260/3265)

Leased Line Connector Pin	Canada/ U. S. A.*	Hong Kong/ United Kingdom	Germany/ Austria	All Other Countries
1	Not Used	Not Used	LA	Not Used
2	Not Used	B	Not Used	Not Used
3	Not Used	Not Used	Not Used	Not Used
4	Ring	Not Used	LB	Ring
5	Tip	A	Not Used	Tip
6	Not Used	Not Used	Not Used	Not Used
7	Not Used		Not Used	Not Used
8	Not Used		Not Used	Not Used

*Refer to Canada/U. S. A. country-specific sections for rear panel pinouts cross-referenced with telco jack selections.

Phone Connector Interface (Models 3260/3265)

Connection to an external telephone can be made using the PHONE connector on the modem's rear panel. Table C-3 describes PHONE connector interface pinouts.

Table C-3.
Phone Line Interface (Models 3260/3265)

Phone Line Connector Pin	Canada/ U. S. A.*	Hong Kong/ United Kingdom	All Other Countries
1	Not Connected	Not Used	Not Used
2	Not Connected	B	Not Used
3	MI	Bell Shunt	Not Used
4	Ring	Not Used	Telset Ring
5	Tip	A	Telset Tip
6	MIC	Not Used	Not Used
7	Not Connected		Not Used
8	Not Connected		Not Used

*Refer to Canada/U. S. A. country-specific sections for rear panel pinouts cross-referenced with telco jack selections.

Dial Line Interface (Models 3261/3266)

Dial line connection is made via the DIAL LINE interface on the modem's rear panel. Table C-4 describes DIAL LINE connector pinouts.

Table C-4.
Dial Line Interface (Models 3261/3266)

Dial Line Connector Pin	Canada/ U. S. A.	Germany/ Austria	Hong Kong/ United Kingdom	Japan	All Other Countries
1	MB	LA	Not Used	Not Used	Not Used
2	MB1	Not Used	B	Not Used	Not Used
3	M1	Ring Indicator	Bell Shunt	Not Used	Telset Ring
4	Ring	LB	Telset Ring	Ring	Ring
5	Tip	b2	A	Tip	Tip
6	MIC	Not Used	Telset Tip	Not Used	Telset Tip
7	PR	Not Used		Not Used	Not Used
8	PC	a2		Not Used	Not Used

2-Wire Leased Line Interface (Models 3261/3266)

2-wire leased line connections are made via the LEASE LINE interface on the modem's rear panel. Table C-5 describes 2-wire leased line interface pinouts.

Table C-5.
2-Wire Leased Line Interface (Models 3261/3266)

Leased Line Connector Pin	Canada/ U. S. A.	Germany/ Austria	Hong Kong/ United Kingdom	Japan	All Other Countries
1	Ring	Tip	Tip	Ring	Ring
2	Tip	Ring	Not Used	Tip	Tip
3	Not Used	Not Used	Not Used	Not Used	Not Used
4	Not Used	Not Used	Not Used	Not Used	Ring
5	Not Used	Not Used	Not Used	Not Used	Tip
6	Not Used	Not Used	Ring	Not Used	Not Used
7	Not Used	Not Used		Not Used	Not Used
8	Not Used	Not Used		Not Used	Not Used

4-Wire Leased Line Interface (Models 3261/3266)

4-wire leased line connections are made via the LEASE LINE interface on the modem's rear panel. Table C-6 describes 4-wire leased line interface pinouts.

Table C-6.
4-Wire Leased Line Interface (Models 3261/3266)

Leased Line Connector Pin	Canada/ U. S. A.	Germany/ Austria	Hong Kong/ United Kingdom	Japan	All Other Countries
1	TX Ring	TX Tip	TX Tip	TX Ring	TX Ring
2	TX Tip	TX Ring	RX Tip	TX Tip	TX Tip
3	Not Used	Not Used	Not Used	Not Used	RX Tip
4	Not Used	Not Used	Not Used	Not Used	TX Ring
5	Not Used	RX Tip	RX Ring	Not Used	TX Tip
6	Not Used	RX Ring	TX Ring	Not Used	RX Ring
7	RX Tip	Not Used		RX Tip	RX Tip
8	RX Ring	Not Used		RX Ring	RX Ring

Phone Connector Interface (Models 3261/3266)

Connection to an external telephone can be made using the PHONE connector on the modem's rear panel. Table C-7 describes PHONE connector interface pinouts.

Table C-7.
Phone Line Interface (Models 3261/326)

Phone Line Connector Pin	Canada/U. S. A.	Japan
1	Not Connected	Not Used
2	Not Connected	Not Used
3	MI	Not Used
4	Ring	Telset Ring
5	Tip	Telset Tip
6	MIC	Not Used
7	Not Connected	Not Used
8	Not Connected	Not Used

Card Models 3262/67, 3263/68 Backplane Interface Pinouts

Dial Line Interface (All Card Models)

Dial line connection is made via the DIAL LINE A and DIAL LINE B interfaces. Table C-8 describes DIAL LINE connector pinouts.

Table C-8.
Dial Line Interface (All Card Models)

Dial Line A and Dial Line B Connector Pin	Canada/U. S. A.	Hong Kong/ South Africa/ United Kingdom	All Other Countries
1	MB	Not Used	Not Used
2	MB1	U.K. Bell	Not Used
3	MI	Telset Ring	Telset Ring
4	Ring	Ring	Ring
5	Tip	Tip	Tip
6	MIC	Telset Tip	Telset Tip
7	PR	Not Connected	Not Used
8	PC	Not Connected	Not Used

2-Wire Leased Line Interface (Models 3262/3267)

2-wire leased line connections are made via the 2W LEASE interface for modem A, and via the 2W/4W LEASE interface for modem B. Table C-9 describes 2-wire leased line interface pinouts.

Table C-9.
2-Wire Leased Line Interface (Models 3262/3267)

2-Wire Lease and 2- and 4-Wire Lease Connector Pin	Canada/U. S. A.	Hong Kong/ South Africa/ United Kingdom	All Other Countries
1	Not Used	Not Used	Not Used
2	Not Used	Not Used	Not Used
3	Not Used	Not Used	Not Used
4	Ring	Ring	Ring
5	Tip	Tip	Tip
6	Not Used	Not Used	Not Used
7	Not Used	Not Connected	Not Used
8	Not Used	Not Connected	Not Used

2-Wire Leased Line Interface (Models 3263/3268)

2-wire leased line connections are made via the 2W/4W LEASE interface. Table C-10 describes 2-wire leased line interface pinouts.

Table C-10.
2-Wire Leased Line Interface (Models 3263/3268)

2- and 4-Wire Lease Connector Pin	Canada/Japan/ U. S. A.	Hong Kong/ South Africa/ United Kingdom	All Other Countries
1	Ring	Not Used	Ring
2	Tip	Not Used	Tip
3	Not Used	Not Used	Not Used
4	Not Used	Tip	Ring
5	Not Used	Ring	Tip
6	Not Used	Not Used	Not Used
7	Not Used	Not Connected	Not Used
8	Not Used	Not Connected	Not Used

4-Wire Leased Line Interface (Models 3263/3268)

4-wire leased line connections are made via the 2W/4W LEASE interface. Table C-11 describes 4-wire leased line interface pinouts.

Table C-11.

4-Wire Leased Line Interface (Models 3263/3268)

Dial Line Connector Pin	Canada/Japan/ U. S. A.	Hong Kong/ South Africa/ United Kingdom	All Other Countries
1	TX Ring	Not Used	TX Ring
2	TX Tip	Not Used	TX Tip
3	Not Used	RX Tip	RX Tip
4	Not Used	TX Tip	TX Ring
5	Not Used	TX Ring	TX Tip
6	Not Used	RX Ring	RX Ring
7	RX Tip	Not Connected	RX Tip
8	RX Ring	Not Connected	RX Ring

Delayed and Forbidden Lists

When operating in certain countries, the modem processes call attempt failures as delayed and forbidden calls. This section describes how delayed/forbidden lists operate in each country that supports this feature.

Australia—Delayed Call Lists

The modem processes call attempt failures as delayed calls, according to PTT regulations. Before dialing a number, the modem determines whether:

- The number is on the delayed list
- The delayed list is full (the list holds 10 numbers)

In either case, the number is not dialed. When the modem is turned off and then on again, the lists are cleared, and the numbers can be dialed.

After dialing, the modem processes the following call failures as delayed calls:

- The modem receives a busy tone after dialing a call
- The call is not answered within the time in the Call Timeout (AT*TT) option

For these call failure conditions, nine subsequent redial attempts are allowed. If the redial call attempts are unsuccessful after a total of 10 calls, the number is placed on the delayed list. Then it cannot be dialed for 30 minutes. After 30 minutes, the number is available for dialing.

Austria—Forbidden Call Lists

The modem processes call attempt failures as forbidden calls, according to PTT regulations. Before dialing a number, the modem determines whether:

- The number is on the forbidden list
- The forbidden list is full (the list holds 16 numbers)

In either case, the number is not dialed. When the modem is turned off and then on again, the lists are cleared, and the numbers can be dialed.

After dialing, the modem processes the following call failures as forbidden calls:

- The modem receives a busy tone after dialing a call, or
- The call is not answered within the time in the Call Timeout (AT*TT) option

For these call failure conditions, 11 subsequent redial attempts are allowed. If either of the above call failure conditions occur more than 12 times, the number is placed on the forbidden list, and calls to this number *are not* allowed.

Belgium—Delayed Call Lists

The modem processes call attempt failures as delayed calls, according to PTT regulations. Before dialing a number, the modem determines whether:

- The number is on the delayed list
- The delayed list is full (the list holds 16 numbers)

In either case, the number is not dialed. When the modem is turned off and then on again, the lists are cleared, and the numbers can be dialed.

After dialing, the modem processes the following call failures as delayed calls:

- The modem receives a busy tone after dialing a call
- The call is not answered within the time in the Call Timeout (AT*TT) option.

For these call failure conditions, three subsequent redial attempts are allowed. If the redial call attempts are unsuccessful after a total of four calls, within one hour, the number is placed on the delayed list. Then it cannot be dialed for 60 minutes. After 60 minutes, the number is available for dialing.

Finland—Delayed Call Lists

The modem processes call attempt failures as delayed calls, according to PTT regulations. Before dialing a number, the modem determines whether:

- The number is on the delayed list
- The delayed list is full (the list holds 16 numbers)

In either case, the number is not dialed. When the modem is turned off and then on again, the lists are cleared, and the numbers can be dialed.

After dialing, the modem processes the following call failures as delayed calls:

- The modem receives a busy tone after dialing a call
- The call is not answered within the time in the Call Timeout (AT*TT) option

For these call failure conditions, four subsequent redial attempts are allowed. If the redial call attempts are unsuccessful after a total of five calls, within one hour, the number is placed on the delayed list. Then it cannot be dialed for 60 minutes. After 60 minutes, the number is available for dialing.

France—Delayed and Forbidden Call Lists

The modem processes call attempt failures as delayed and forbidden calls, according to PTT regulations. Before dialing a number, the modem determines whether:

- The number is on the delayed or forbidden list
- The delayed or forbidden lists are full (the list holds 16 numbers)

In either case, the number is not dialed. When the modem is turned off and then on again, the lists are cleared, and the numbers can be dialed.

The following criteria determine on which list the number is placed:

- **Delayed List.** The modem detects one of the following “delay conditions:”
 - The modem receives a busy tone after dialing a call
 - The call is not answered within the time in the Call Timeout (AT*TT) option

If one or both of these conditions is detected for six consecutive calls, the number is placed on the delayed list. Then it cannot be dialed for 60 minutes. After 60 minutes, the number is available for dialing.

- **Forbidden List.** The modem detects a “forbidden condition:”
 - A call is dialed by the modem, and answered by a remote modem, but an Answer Back Tone (ABT) is not detected by the calling modem
 - A call is manually aborted via the front panel or the V.25 bis ACU

If the modem detects two occurrences of a forbidden condition for a number within a 2-minute period, the number is placed on the forbidden list and no calls are allowed to this number. If the call is successfully dialed within the 2-minute period, the forbidden condition is cleared. If not, the number remains on the forbidden list, and calls to this number are not allowed until the modem is powered down and then turned on again.

Hong Kong—Delayed Call Lists

The modem processes call attempt failures as delayed calls, according to PTT regulations. Before dialing a number, the modem determines whether:

- The number is on the delayed list
- The delayed list is full (the list holds five numbers)

In either case, the number is not dialed. When the modem is turned off and then on again, the lists are cleared, and the numbers can be dialed.

After dialing, the modem processes the following call failures as delayed calls:

- The modem receives a busy tone after dialing a call
- The call is not answered within the time in the Call Timeout (AT*TT) option

For these call failure conditions, three subsequent redial attempts are allowed. If the redial call attempts are unsuccessful after a total of four calls, the number is placed on the delayed list. Then it cannot be dialed for 15 minutes. After 15 minutes, the number is available for dialing.

Ireland—Delayed Call Lists

The modem processes call attempt failures as delayed calls, according to PTT regulations. Before dialing a number, the modem determines whether:

- The number is on the delayed list
- The delayed list is full (the list holds 16 numbers)

In either case, the number is not dialed. When the modem is turned off and then on again, the lists are cleared, and the numbers can be dialed.

After dialing, the modem processes the following call failures as delayed calls:

- The modem receives a busy tone after dialing a call, or
- The call is not answered within the time in the Call Timeout (AT*TT) option

For these call failure conditions, three subsequent redial attempts are allowed. If the redial call attempts are unsuccessful after a total of four calls, within one hour, the number is placed on the delayed list. Then it cannot be dialed for 60 minutes. After 60 minutes, the number is available for dialing.

Netherlands—Delayed Call Lists

The modem processes call attempt failures as delayed calls, according to PTT regulations. Before dialing a number, the modem determines whether:

- The number is on the delayed list
- The delayed list is full (the list holds 16 numbers)

In either case, the number is not dialed. When the modem is turned off and then on again, the lists are cleared, and the numbers can be dialed.

After dialing, the modem processes the following call failures as delayed calls:

- The modem receives a busy tone after dialing a call, or
- The call is not answered within the time in the Call Timeout (AT*TT) option

For these call failure conditions, 14 subsequent redial attempts are allowed. If the redial call attempts are unsuccessful after a total of 15 calls, within one hour, the number is placed on the delayed list. Then it cannot be dialed for 60 minutes. After 60 minutes, the number is available for dialing.

Norway—Delayed Call Lists

The modem processes call attempt failures as delayed calls, according to PTT regulations. Before dialing a number, the modem determines whether:

- The number is on the delayed list
- The delayed list is full (the list holds 16 numbers)

In either case, the number is not dialed. When the modem is turned off and then on again, the lists are cleared, and the numbers can be dialed.

After dialing, the modem processes the following call failures as delayed calls:

- The modem receives a busy tone after dialing a call
- No dial tone was detected
- The call is not answered within the time in the Call Timeout (AT*TT) option

For these call failure conditions, nine subsequent redial attempts are allowed. If the redial call attempts are unsuccessful after a total of ten calls, the number is placed on the delayed list. Then it cannot be dialed for 30 minutes. After 30 minutes, the number is available for dialing.

Spain—Delayed Call Lists

The modem processes call attempt failures as delayed calls, according to PTT regulations. Before dialing a number, the modem determines whether:

- The number is on the delayed list
- The delayed list is full (the list holds 16 numbers)

In either case, the number is not dialed. When the modem is turned off and then on again, the lists are cleared, and the numbers can be dialed.

After dialing, the modem processes the following call failures as delayed calls:

- The modem receives a busy tone after dialing a call
- The call is not answered within the time in the Call Timeout (AT*TT) option

For these call failure conditions, three subsequent redial attempts are allowed. If the redial call attempts are unsuccessful after a total of four calls, the number is placed on the delayed list. Then it cannot be dialed for 60 minutes. After 60 minutes, the number is available for dialing.

Other Country-Specific Information

This section contains information that applies to the following countries:

- Canada
- Denmark
- Hong Kong
- Spain
- United Kingdom
- U. S. A.

Canada

DOC Registration and Requirements

To comply with the Department of Communications (DOC) registration requirements, you must give the following information to the telephone company:

- **Manufacturer and modem model number:** 3265, 3266, 3267, or 3268
- **Telephone number(s)** to which the modem will be connected
- **DOC Registration Number:** 725-3906A (Model 3265), 725-3906AB (Model 3266), 725 4124 AB (Models 3267/3268)
- **Load Number:** 4

Industry Canada Equipment Attachment Limitations

The Industry Canada label on equipment means it has been tested and found to meet requirements for telecommunications operation and safety in Canada. The label does not guarantee, however, that the equipment will operate to your satisfaction.

Repairs to certified equipment should be made by an authorized Telenetics agent. If the equipment malfunctions due to any unauthorized repair or alteration, the telecommunications company may request that you disconnect the equipment.

Ensure that connection to local telecommunications company facilities is permissible and that the equipment is installed properly. Compliance with the above conditions may not prevent degradation of service in some situations.

Ground connections for power and telephone lines should be wired to a single ground line. This may be particularly important in rural areas. These connections should be made by a qualified electrician. If already installed, the connections should be inspected by the appropriate electrical inspection authority.

To prevent circuit overload, each piece of equipment is assigned a Load Number (LN), which denotes the percentage of the total load used by the device in a telephone loop. This equipment has a load number of 4. You may use any combination of devices on a loop, subject only to the requirement that the total of the load numbers of all the devices does not exceed 100.

The standard connecting arrangement codes for the equipment are as follows: CA02B, CA11A, CA40A, CA41A, and CA45A.

Canadian Emissions Statement

This Class A digital apparatus meets all requirements of the Canadian Interference Causing Equipment Regulations.

Cet appareil numérique de la classe A respecte toutes les exigences du Règlement sur le matériel brouilleur du Canada.

Rear Panel Pinouts

This section provides the rear panel pinouts for the 3265/3266 Modem, cross-referenced to the pinouts for the telco jacks supported in Canada.

3265 Modem

Table C-12 describes dial line connector pinouts for RJ jack types.

Table C-12.
DIAL LINE Connector Pinouts for Jack Operation

<i>Dial Line Connector Pin No.</i>	<i>Dial Line Jack Function</i>	<i>Telco Jack Selection</i>				
		<i>RJ4MB</i>	<i>RJ45S (CA45A)</i>	<i>RJ16C</i>	<i>RJ11C (CA11A)</i>	<i>Leased Line</i>
1	MB	X	Not Used	Not Used	Not Used	Not Used
2	MB1	X	Not Used	Not Used	Not Used	Not Used
3	MI	X	X	X	Not Used	Not Used
4	Ring	X	X	X	X	X
5	Tip	X	X	X	X	X
6	MIC	X	X	X	Not Used	Not Used
7	PR	X	X	Not Used	Not Used	Not Used
8	PC	X	X	Not Used	Not Used	Not Used

X = active signal.

Table C-13 describes PHONE connector pinouts for RJ jack types.

Table C-13.
PHONE Connector Pinouts for Jack Operation

<i>Phone Connector Pin No.</i>	<i>Phone Jack Function</i>	<i>Telco Jack Selection</i>			
		<i>RJ4MB</i>	<i>RJ45S (CA45A)</i>	<i>RJ16C</i>	<i>RJ11C (CA11A)</i>
1	N/C	N/C	N/C	N/C	N/C
2	N/C	N/C	N/C	N/C	N/C
3	MI	X	X	X	Not Used
4	Ring	X	X	X	X
5	Tip	X	X	X	X
6	MIC	X	X	X	Not Used
7	N/C	N/C	N/C	N/C	N/C
8	N/C	N/C	N/C	N/C	N/C

N/C = Not Connected. X = active signal.

3266 Modem

Table C-14 describes dial line connector pinouts for RJ jack types.

Table C-14.
DIAL Line Connector Pinouts for Jack Operation

<i>Dial Line Connector Pin No.</i>	<i>Dial Line Jack Function</i>	<i>Telco Jack Selection</i>			
		<i>RJ4MB</i>	<i>RJ45S (CA45A)</i>	<i>RJ16C</i>	<i>RJ11C (CA11A)</i>
1	MB	X	Not Used	Not Used	Not Used
2	MB1	X	Not Used	Not Used	Not Used
3	MI	X	X	X	Not Used
4	Ring	X	X	X	X
5	Tip	X	X	X	X
6	MIC	X	X	X	Not Used
7	PR	X	X	Not Used	Not Used
8	PC	X	X	Not Used	Not Used

X = active signal.

Table C-15 describes the Phone connector pinouts for RJ jack types.

Table C-15.
PHONE Connector Pinouts for Jack Operation

<i>Phone Connector Pin No.</i>	<i>Phone Jack Function</i>	<i>Telco Jack Selection</i>			
		<i>RJ4MB</i>	<i>RJ45S (CA45A)</i>	<i>RJ16C</i>	<i>RJ11C (CA11A)</i>
1	N/C	N/C	N/C	N/C	N/C
2	N/C	N/C	N/C	N/C	N/C
3	MI	X	X	X	Not Used
4	Ring	X	X	X	X
5	Tip	X	X	X	X
6	MIC	X	X	X	Not Used
7	N/C	N/C	N/C	N/C	N/C
8	N/C	N/C	N/C	N/C	N/C

N/C = Not Connected. X = active signal.

Telco Option (AT&J)

Telco displays only on U.S.A. and Canadian 326X Series Modems. It is used to select the RJ-jack type. Telco corresponds to the AT&J command as follows:

<i>Front Panel Option Setting</i>	<i>AT Command Option Setting</i>
RJ11C	0, 1
RJ45S	2
RJ16C	3
RJ4MB	4

Denmark—Blind Dialing

326X Series Modem users in Denmark must comply with the requirements in the “Regulation Regarding Teleterminal Equipment” (No. 882, October 29, 1992), available from the Danish Minister of Communications.

The setup of the modem must comply exactly with the restrictions within this Denmark section and as specified in the Restricted Features Summary in this guide.

The factory default settings are in accordance with this requirement, and the modem is shipped from Telenetics with compliant settings.

Hong Kong and United Kingdom—BABT Regulations

The following sections outline the BABT regulations as they relate to Telenetics 3265 and 3266 Modem operation in Hong Kong and the United Kingdom.

Compliance with BS6328: Part 1: 1982 Section 8.3

This modem is not suitable for use with circuits employing British Telecommunications (BT) signaling of 2280 Hz.

The equipment detailed in this guide is designed for use on a 2- or 4-wire point-to-point private circuit. It is not suitable for omnibus or multipoint circuits.

The frequency range of DC to 200 Hz is not used.

Compliance with BS6328: Part 1: 1982 Section 8.7

There is no DC interaction between the modem and the British Telecommunications private circuit.

Compliance with BABTSITS/82/01/C and BABT/SITS/82005S/D

The approval of this modem for connection to British Telecommunications private speechband circuits is invalid if the apparatus is subject to any modification not authorized by the British Approvals Board of Telecommunications (BABT) or if it is used with or connected to any of the following:

- Internal software that has not been formally accepted by BABT.
- External software or external control apparatus that causes the operation of the modem or associated call setup equipment to contradict the requirements of the standards set out in BABT/SITS/82/01/C or BABT/SITS/82/005S/D.

All apparatus connected to this modem and thereby connected directly or indirectly to British Telecommunications private speechband circuits must be approved apparatus as defined in Section 16 of the British Telecommunications Act of 1981.

Compliance with BS6305 Clause 6.2, BS6320 Clause 7.2

The modem is suitable for connection to the public switched telephone network (PSTN) provided by British Telecommunications PLC or Hull City Council Telephone Department.

The modem is suitable for household, office, and general indoor use. It is not suitable for use as an extension to a pay phone, shared service, or 1+1 carrier systems.

The modem has been approved for the use of the following facilities:

- Loop disconnect and MF signaling
- Auto answer
- Auto calling

You may connect the modem to a BT line that has loop-disconnect or MF signaling.

Ringer Equivalence Number (REN)

This modem has a REN value of 3.

The REN is a customer guide that indicates, in approximate terms, the maximum number of items that may be connected simultaneously to a telephone line. The REN, obtained by summing the REN values of each of the items of apparatus connected to the exchange line, should not exceed 4. This value includes BT-provided instruments, each of which is assumed to have a REN of 1.0 unless otherwise marked.

Compliance with BAPT/SITS/83/08/A Clause 1.2

The modem cannot allow Auto Call using “999” or other PABX emergency numbers.

Modes other than 1, 2, or 3 should not be used on the BT PSTN. This modem is a mode 1 device.

Check the numbers entered during the Auto Call setup phase prior to dialing.

Compliance with BS6789: Section 6.1:1986 Clause 5.2

The modem should not be used in conjunction with other series-connected apparatus such that the aggregate declared voltage drops of all this apparatus, together with the voltage drop introduced at 40mA by any separate wiring used to link items of apparatus, exceeds 2.0V.

For statutory purposes, apparatus connected to the PSTN via a Relevant Branch System (RBS) is treated as if connected directly to the PSTN. Refer to BS6789 Section 6.1 para 2.4 for the definition of an RBS.

Compliance with BS6789: Section 6.1:1986 Clause 7.3.1.3

When making calls from other apparatus connected to the PSTN via the series apparatus, difficulties may be experienced in:

- Making calls
- Telephone conversations (by both parties)

If you experience difficulty, refer to the modem supplier, not the network operator.

Compliance with BS6789: Section 6.1:1986 Clause 7.3.1.4

This modem causes a voltage drop of 1.7V at a line current of 40mA.

Compliance with DTI 83/009I

This modem has been approved for use of the following facilities:

- Loop disconnect and multifrequency signaling
- Storage of telephone numbers for retrieval by a predetermined code
- Detection of initial proceed indication
- Operation of the absence of proceed indication
- Automatic dialing facilities
- Tone detection, i.e., Ring Tone, etc.
- Multiple repeat attempt facility
- Automatic clearing from call originating end
- Call progress monitor
- Series connection
- Modem
- PBX timed break register recall
- Auto answer

Any other usage will invalidate the approval of the apparatus if, as a result, it ceases to conform to the standards against which approval was gained.

This apparatus is only approved for compatible PBXs. Telenetics should be consulted for an up-to-date list of compatible PBXs.

There is no guarantee that the apparatus will work in all circumstances. Any difficulty should be referred to Telenetics.

This apparatus is suitable for connection to a PABX which returns secondary proceed indication.

Compliance with BS6301

Only apparatus conforming with BS6301 may be connected to the telephone socket on the rear of the modem.

Any interconnection between the above socket and the other modem connections, directly or by way of other apparatus, may produce hazardous conditions on the BT network. Advice should be obtained from a competent engineer before any such connection is made.

Compliance with BAPT SITS 83/009 Section D



Caution

Do not enter more than two “4” second pauses following the initial access digit (or digits). Failure to comply with this requirement may result in unsatisfactory operation.

Installation of Telephone Socket

If you need to obtain a suitable British Telecom socket or extension, make a photocopy of the following form, complete all the necessary information, and return it to your local telephone sales office.

Application for Installation of Telephone Socket

Complete this application and send it to your local telephone sales office only if a suitable British Telecom socket or extension is required.

I am the owner of a _____ modem.

Model _____

Approval Number _____

Please arrange to fit two new plan modular sockets as soon as possible.

Name _____

Address _____

Telephone Numbers _____

Date _____ Signed _____

U. S. A.

FCC Registration

This equipment complies with Part 68 of the FCC rules. On the bottom of your 3260, or 3261 Modem, the nameplate label contains the FCC registration number and ringer equivalence number (REN) for your modem. If requested by the telephone company, you must provide this information.

This equipment supports the following USOC service codes (switched analog dial): RJ11C, RJ16C, RJ45S, and RJ4MB.

The REN is used to determine the number of devices that can be connected to the telephone line. Excessive RENs on the telephone line may result in the devices not ringing in response to an incoming call. In most, but not all areas, the sum of the RENs should not exceed five.

To be certain of the number of devices that can be connected to the line, as determined by the total RENs, contact the telephone company to determine the maximum REN for the calling area.

If this equipment causes harm to the telephone network, the telephone company will notify you. If advance notice is not practical, the telephone company will notify you as soon as possible. Also, you will be advised of your rights to file a complaint with the FCC if you believe it is necessary.

The telephone company may make changes to its facilities, equipment, operations, and procedures that can affect the operation of your modem. If this happens, the telephone company provides you advance notice for making the necessary modifications to your modem to maintain uninterrupted service.

Also, this equipment cannot be used on telephone company-provided coin service. Connection to a party line is subject to state tariffs.

If you experience problems with this equipment, contact Telenetics for repair and/or warranty information. If the trouble is causing harm to the telephone network, the telephone company may request that you remove the equipment from the network until the problem is resolved.

FCC Regulations

The Federal Communications Commission (FCC) of the U. S. A. has published regulations that govern the allowable limits of emissions of radio frequency energy for computing devices and associated peripherals. These regulations are concerned with interference to radio communications, such as radio and television. The regulations require equipment for end use in the U. S. A. to be labeled and to be accompanied by the warning which appears on the Notice page at the beginning of this manual.

There is no guarantee, however, that interference will not occur in a particular installation. If it does, you may be required, at your own expense, to take whatever measures are necessary to correct the situation.

Interference to radio or television reception can be determined by turning the equipment off and on. If interference is present, try the following:

- Reorient the receiving antenna.
- Relocate the equipment with respect to the receiver.
- Move the equipment away from the receiver.
- Plug the equipment into a different outlet so that the equipment and the receiver are on different branch circuits.
- Consult the dealer or an experienced radio/television technician.

You may find the following booklet prepared by the FCC helpful: *How to Identify and Resolve Radio-TV Interference Problems*, available from the U.S. Government Printing Office, Washington, D.C. 20402 (Stock No. 004-000-00345-4).

Dial Line Jack Types

The Federal Communication Commission (FCC) is a telecommunications and standards organization that specifies a series of registered jacks for use with a dial line network or General Switched Telephone Network (sometimes referred to as PSTN). These jacks are designated as RJxxx-type jacks, where RJ means Registered Jack and xxx specifies the jack series. For example, RJ11 indicates a registered jack from series 11. Sometimes the jack designation is followed by a letter (RJ11C) that indicates the jack housing style. Jacks specified under FCC Part 68 fit into one of the following categories: Permissive (voice) or Programmable (data).

6-Pin Voice Jack (Permissive)

This jack type primarily allows voice signals transmitted across lines designated for voice transmission. This jack type also allows data signals to be transmitted across voice-grade lines.

8-Pin Data Jack (Programmable)

This jack type is designed to ensure voiceband data transmission integrity across an interface cable. The jack is referred to as “programmable” because it contains a resistor that allows the phone company to adjust for the optimum output power level before the DCE is connected to the line. The following jack types can be used with your modem.

<i>Jack Type</i>	<i>Description</i>
RJ11C	This 6-pin modular jack type is the most common permissive data mode (voice) jack arrangement found in the home or office. This jack operates on a single-line bridged tip-and-ring voice or low-speed data application service.
RJ16C	This 6-pin modular jack type is a special permissive data mode jack arrangement that allows use of an exclusion-key telephone.
RJ45S	This 8-pin modular jack type is the most common programmable data mode (data) jack arrangement; it permits the use of an exclusion-key telephone. This jack also operates on a single-line bridged tip-and-ring voice or low-speed data application service.
RJ4MB	This 8-pin modular programmable data mode jack arrangement supports Make Busy operation. Using this jack type, you can make the modem appear to be off-hook to the central telephone office.

NOTE: Jack type is defined to the modem using the Telco option in the TELCO OPT'S menu. For details, refer to “Declaring The Jack Type” section later in this appendix.

Rear Panel Pinouts

This section provides modem rear panel pinouts, cross-referenced to the pinouts for the telco jacks supported in the U. S. A.

3260 Modem

Table C-16 describes DIAL LINE connector pinouts for RJ jack types. X indicates the signal is active.

Table C-16.
DIALLINE Connector Pinouts for Jack Operation

DIAL LINE Connector Pin No.	DIAL Line Jack Function	TELCO Jack Selection				Leased Line
		RJ4MB	RJ45S	RJ16C	RJ11C	
1	MB	X	Not Used	Not Used	Not Used	Not Used
2	MB1	X	Not Used	Not Used	Not Used	Not Used
3	MI	X	X	X	Not Used	Not Used
4	Ring	X	X	X	X	X
5	Tip	X	X	X	X	X
6	MIC	X	X	X	Not Used	Not Used
7	PR	X	X	Not Used	Not Used	Not Used
8	PC	X	X	Not Used	Not Used	Not Used

Table C-17 describes PHONE connector pinouts for RJ jack types. X indicates the signal is active.

Table C-17.
PHONE Connector Pinouts for Jack Operation

PHONE Connector Pin No.	PHONE Jack Function	TELCO Jack Selection			
		RJ4MB	RJ45S	RJ16C	RJ11C
1	N/C	N/C	N/C	N/C	N/C
2	N/C	N/C	N/C	N/C	N/C
3	MI	X	X	X	Not Used
4	Ring	X	X	X	X
5	Tip	X	X	X	X
6	MIC	X	X	X	Not Used
7	N/C	N/C	N/C	N/C	N/C
8	N/C	N/C	N/C	N/C	N/C

N/C = Not Connected

3261 Modem

Table C-18 describes DIAL LINE connector pinouts for RJ jack types. X indicates the signal is active.

Table C-18.
DIAL LINE Connector Pinouts for Jack Operation

PHONE Connector Pin No.	PHONE Jack Function	TELCO Jack Selection			
		RJ4MB	RJ45S	RJ16C	RJ11C
1	MB	X	Not Used	Not Used	Not Used
2	MB1	X	Not Used	Not Used	Not Used
3	MI	X	X	X	Not Used
4	Ring	X	X	X	X
5	Tip	X	X	X	X
6	MIC	X	X	X	Not Used
7	PR	X	X	Not Used	Not Used
8	PC	X	X	Not Used	Not Used

Table C-19 describes PHONE connector pinouts for RJ jack types. X indicates the signal is active.

Table C-19.
PHONE Connector Pinouts for Jack Operation

PHONE Connector Pin No.	PHONE Jack Function	TELCO Jack Selection			
		RJ4MB	RJ45S	RJ16C	RJ11C
1	N/C	N/C	N/C	N/C	N/C
2	N/C	N/C	N/C	N/C	N/C
3	MI	X	X	X	Not Used
4	Ring	X	X	X	X
5	Tip	X	X	X	X
6	MIC	X	X	X	Not Used
7	N/C	N/C	N/C	N/C	N/C
8	N/C	N/C	N/C	N/C	N/C

N/C = Not Connected

Dial and Leased Line Transmit Levels

Dial Line Transmit Level

Your 3260, 3261, 3262, or 3263 Modem does not support the DL TX option. You select the dial line transmit level through the Telco option in the TELCO OPT's category. Use the following as a guide:

Telco Jack Selection **Dial Transmit Level**

RJ11C (Permissive)	-9 dBm
RJ45S (Programmable)	Programmable transmit level. The transmit level is -12 dBm if pins 7 and 8 on the jack are open (not connected). Otherwise, the transmit level will be determined by the programming resistor value (contact the Telco for further information).

Leased Line Transmit Level

Front Panel Option: LL TX Level

Factory Default: 0 dBm

The leased line transmit level for the 3260, 3261, 3262, or 3263 Modem is adjustable from 0 to -15 dBm in 1 dBm increments.

Making Telephone-to-Modem Connections

To use a telephone with your modem, connect the telephone cable to the PHONE jack at the rear of the modem.

Connecting an Exclusion Key Telephone

In some cases, you can connect an exclusion key telephone to the modem for manual dialing and answering or normal voice communication. This allows you to answer and initiate calls manually with the telephone and then connect the modem to the line by switching the exclusion key. Install an exclusion key telephone as follows:

- 1) Connect the exclusion key telephone to the RJ36 jack if your modem is connected to an RJ4MB/RJ36, RJ45S/RJ36, or RJ16C/RJ36 combination.
- 2) Connect the 8-pin modular cable from the modem DIAL LINE jack to the RJ11C, RJ4MB, RJ45S, or RJ16C data jack.

Connect the exclusion key telephone to the PHONE jack on the rear panel if your modem is not connected to an RJ36 jack combination.

- 3) From the TELCO OPT'S menu, set the Telco option to a jack type (RJ16C, RJ45S, or RJ4MB) supporting the exclusion key feature.

Telco Option (AT&J)

Telco displays only on U. S. A. and Canadian 326X Series Modems. It is used to select the RJ-jack type. Telco corresponds to the AT&J command as follows:

<i>Option Setting</i>	<i>AT Command</i>
RJ11C	0, 1
RJ45S	2
RJ16C	3
RJ4MB	4

Declaring The Jack Type

Once 326x Ready displays, you must declare the jack type you used to connect your modem to the dial/leased line so that the modem recognizes this connection (see Tables C-16 or C-18). You can declare the jack type as follows:

- 1) Press ▼ until TELCO OPT'S is displayed.
- 2) Use ► to move through the TELCO OPT'S menu until Telco = jack type is displayed. For example, you may see Telco = RJ16C in the display.
- 3) Press ▼ until you see the jack type you used to connect your modem to the dial/leased line. For example, you can select Telco:RJ11C.
- 4) Press Ⓞ. In this example Telco = RJ11C is displayed.

You have now declared to the modem the jack type you are using.

If this is the first-time you are installing the modem, the modem is set (factory default) for connection to an RJ11C permissive jack. Installation is complete.

If this is not a first-time installation, connect the modem to an RJ45S programmable jack and set the Telco option for this jack type. To use a programmable jack, contact your telephone company to arrange for installation.

NOTE: You can also select the dial line jack type using the AT&J command. Refer to Appendix A for details.

Using the Modular Nest Backplane's Busy Out Feature

This section applies to the following countries, which use the “Universal International” (UI) Modular Nest enclosure backplane:

- Australia
- Belgium
- Canada
- Denmark
- Finland
- Ireland
- Israel
- Norway
- Sweden
- Switzerland
- U. S. A.

This section also is of interest to users in Hong Kong and the United Kingdom.

Make Busy versions of Modular Nest 9 and Modular Nest 21 **backplanes** (which install in a Modular Nest enclosure with card modems) come equipped with the **Busy Out** feature. This feature causes a Busy Out modem to “appear busy” to the central office when:

- Power is disconnected from the Modular Nest enclosure
- The modem card is not present in its slot
- **Busy Out=ON** (the option is set through the front panel menu, the AT ACU, or a network manager)

Busy Out is intended for use with Model 3262 and 3267 **dial** modems. In some countries, it is also used in **dial-restoral mode** on Model 3263 and 3268 **leased** modems.

Make Busy backplanes are factory configured for Busy Out operation in their country destination, as indicated in Table C-20 or Table C-21.

Table C-20. Backplane Pin Settings for Busy Out, Modular Nest 9

Pin Pair	Function	U. S. A. and Canada:	Other UI Countries:
Left ¹	TIP and RING	No jumper connector	Connected with jumper
Right ¹	Make Busy and Make Busy 1	Connected with jumper	No jumper connector; not applicable

¹Inner backplane surface, as viewed from the rear of the Modular Nest.

Table C-21. Backplane Pin Settings for Busy Out, Modular Nest 21

Pin Pair	Function	U. S. A. and Canada:	Other UI Countries:
Left ¹	Make Busy and Make Busy 1	Connected with jumper	No jumper connector; not applicable
Right ¹	TIP and RING	No jumper connector	Connected with jumper

¹Inner backplane surface, as viewed from the rear of the Modular Nest.



Warning

Only **qualified service personnel** should remove pin jumpers. A qualified service person is one who is familiar with product operation, trained in the technology of electrically powered information processing and business equipment and adequately aware of the hazards associated with this equipment. Removal by unqualified personnel could result in **personal injury** or **equipment damage**, which could jeopardize your warranty and maintenance agreement. Users who are not qualified to perform this action themselves should contact Telenetics or an authorized distributor regarding available upgrade services.



Avertissement

Seul un **personnel qualifié** est autorisé à enlever les cavaliers. Nous appelons qualifiée toute personne familière avec le fonctionnement du produit, ayant suivi une formation dans la technique du traitement de l'information et des équipements de bureau par système électrique et connaissant les dangers liés à ces équipements. Le recours à un personnel non qualifié pour cette opération risque d'entraîner des **dommages corporels et matériels** ainsi que l'invalidité éventuelle du contrat de garantie et de maintenance. Nous conseillons aux utilisateurs non qualifiés pour effectuer cette procédure de contacter Telenetics ou un distributeur agréé pour obtenir une liste des services de mise à jour disponibles.



Warnung

Kontaktstiftüberbrückungen sollten nur von **qualifiziertem Kundendienstpersonal** entfernt werden. Ein qualifizierter Kundendiensttechniker ist vertraut mit dem Betrieb des Produkts, ausgebildet für die Technologie der mit Strom versorgten Datenverarbeitung und Unternehmensgeräten sowie informiert über die Gefahren, die von diesen Geräten ausgehen können. Werden diese Komponenten von unqualifiziertem Personal entfernt, kann dies **Verletzungen von Personen** oder **Geräteschäden** zur Folge haben und Ihre Garantie- und Wartungsvereinbarung gefährden. Anwender, die keine Berechtigung zum Durchführen dieses Vorgangs besitzen, sollten Upgradedienste von Telenetics oder einem autorisierten Händler anfordern.

Refer also to Figure C-10, which shows pin locations on Modular Nest 21 backplanes. Modular Nest 9s have a similar layout.

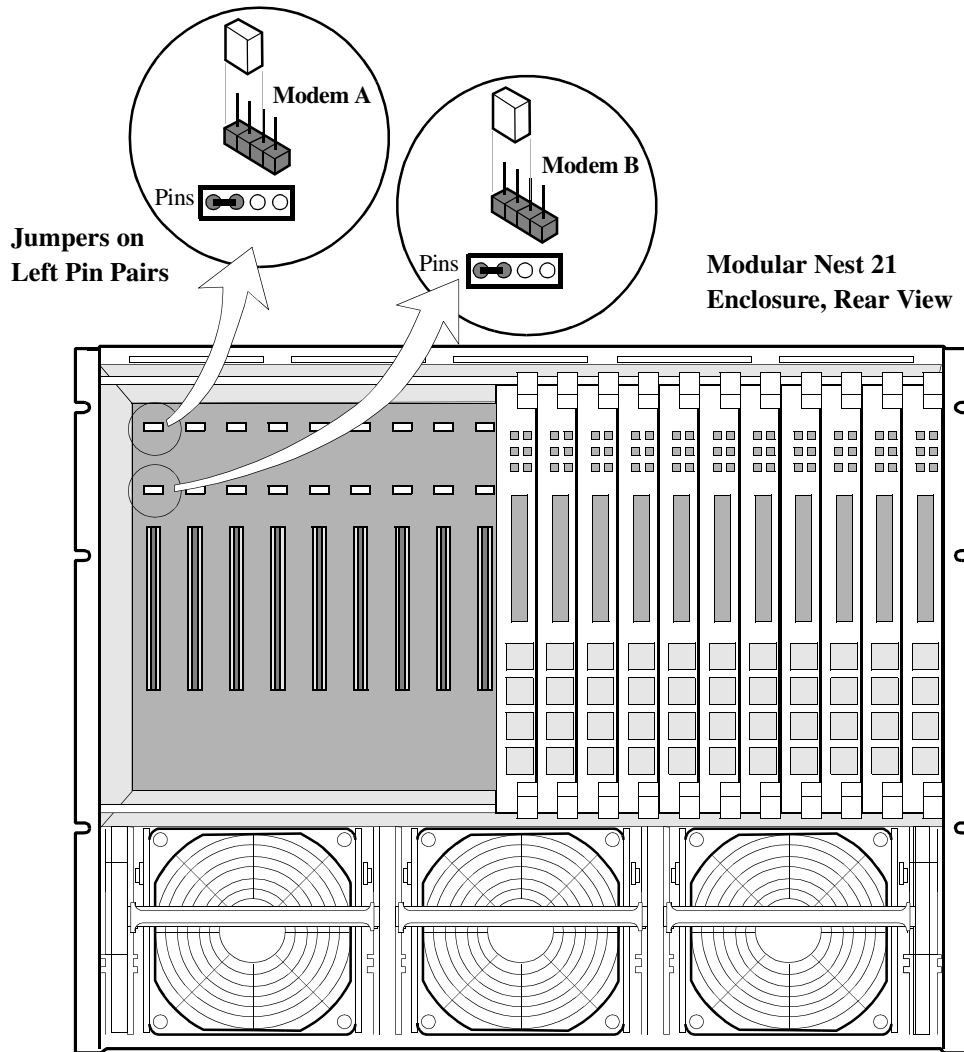

Figure C-10. Modular Nest Backplane Pin Locations (Modular Nest 21 Shown)

In Hong Kong and the United Kingdom, Busy Out backplanes are hard-wired for Busy Out operation. These backplanes do not use pin jumpers.

This glossary defines terms used in data communications and in the *326X Series Modem* documentation set.

ACU	Automatic Calling Unit or Auto-Call Unit. Internal or external to the DCE, the ACU is a command set interface between the attached DTE and the modem that uses the normal DTE/DCE interface. The ACU allows for direct modem control and configuration by the DTE.
Analog signal	In data communications, a continuously varying signal (such as the human voice), which conventional telephone lines are designed to transmit. For transmission on these lines, the digital output from a computer or terminal must be converted to an analog signal.
ASCII	American Standard Code for Information Interchange. A method of coding digital signals using seven bits (or eight bits with parity) to generate 96 different characters.
Asynchronous	Data without an accompanying time signal. Timing is derived from the asynchronous data with character boundaries defined by start and stop bits.
Auto-answer	Automatic answering. A modem responds to an incoming call over a dial line and establishes contact with a remote modem.
Baud	The rate at which discrete signal elements are transmitted. In asynchronous transmission, baud rate=bit rate. In most synchronous transmissions, the baud rate is an integer submultiple of the bit rate. For example, in V.22 bis QAM modulation, four bits are sent in each baud. If the baud rate is 600, V.22 bis transmits at 2400 (600 x 4) bits per second (bps).
Baudot code	A method of coding digital signals using five bits to generate 58 different characters.
Baud rate	See Baud.
BCC	Block check character. A unique number derived from data transmitted in a block. The character is appended to data blocks for use in determining whether a block is received with errors.
BER	Bit Error Rate. The percentage of bit errors relative to a specific number of bits received; usually expressed as a number referenced to a power of 10.
Binary	A base two numerical representation system using two digits, 0 (zero) and 1 (one); in the case of a computer, Off and On.
Bit	A blend of the two words <u>b</u> inary and <u>dig</u> it. The smallest unit in a byte of information, expressed as 0 (zero) or 1 (one).
Bit-oriented	A communications protocol or transmission procedure in which control information is encoded in fields of one or more bits. Compare with Character-Oriented.
Block error	(1) A specified number of transmitted data bits over which an encoding procedure is applied for error-control purposes. A specified number of data characters or bits. (2) A quantity of transmitted information, or data, usually determined by its own starting and ending control characters.
bps	The rate at which data passes over the telephone line, in bits per second.

Busy out	An indication to a Central Office that a subscriber line is not available to answer incoming calls. The availability and implementation of Busy Out varies by country.
Byte	An 8-bit sequence of binary digits (bits) taken as a single unit by a computer.
CCITT. See ITU.	Consultative Committee on International Telephone and Telegraph. International data communications standards group.
Character	A group of bits used to represent one digit, letter, or symbol (often in 7- or 8-bit groups).
Character-oriented	A communications protocol that carries control information encoded in fields of one or more characters. Compare with Bit-Oriented.
Control characters	In data communications, any additional transmitted characters that control or facilitate data transmission between data terminals.
CRC	Cyclic Redundancy Check. A BCC error-checking mechanism for link-level data transmission.
Crossover cable	Special DTE/DCE interface cable that reassigns signals from specific pins, thus allowing normal data transfer between two DTEs or two DCEs at the same site.
CTS	Clear To Send. The signal passed from the local modem to the local terminal when the data port is ready to transmit data. Usually occurs in response to Request To Send (RTS).
Data compression, synchronous	See Synchronous Data Compression.
dB	Decibel. A unit used to express relative difference in power between acoustic or electric signals, equal to ten times the common logarithm of the ratio of the two power levels. An increase of 3 dB is equal to doubling the power; a decrease of 3 dB is equal to halving the power.
dBm	A measure of power in communications: the decibel referenced to one milliwatt into a 600-ohm load (0 dBm = 1 milliwatt).
DCD	Data Carrier Detect. Also known as the Received Line Signal Detector (RLSD). This signal is passed from a local modem to a local DTE when an acceptable carrier signal is received by the modem over the telephone line.
DCE	Data Communications Equipment. A modem or other data transmission device.
Demodulation	In data communications, retrieval of an original digital data signal from a modulated analog signal.
Digital signal	The binary 0 (off) and 1 (on) output of a data terminal. Modems convert digital signals into analog waves for transmission over conventional telephone lines.
DSR	Data Set Ready. This signal is passed from the local modem. Indicates that the local modem is ready to enter the data transmission phase.
DTE	Data Terminal Equipment. End user devices that generate or receive data and that provide data communications control functions. Examples include: central processing units (CPUs), front-end processors (FEPs), high-speed multiplexers, PCs, user terminals, and so on.

DTMF	Dual Tone Multi-Frequency. A signaling method used for push-button telephones that combines two output signals to create a unique tone for each of the 12 keys.
EBCDIC	Extended Binary Coded Decimal Interchange Code. A method of coding digital signals using eight bits to generate 256 different characters.
Echo	Reflection back to the sender of a transmitted signal (as heard on telephone circuits involving long distances, or poor transmission facilities).
EIA	Electronic Industries Association. The American electronics standards group.
EIA/TIA 232-D	The most commonly used computer/modem interface. An electrical standard for interconnecting data communications equipment (DCE) and data terminal equipment (DTE) established by EIA. (The pinout is the same as for EIA 232-C and is nearly equivalent to ITU V.24.)
EOT	End-of-transmission control character in character-oriented protocols (applied to BISYNC). Tells the receiver that all user data (text) has been sent.
ETX	End-of-text control character. Tells the receiver that the end of a message has been reached.
Exclusion key telephone	Allows calls to be answered manually and transferred to the modem using an integral exclusion key.
Fallback	Switching the data system to a lower transmission speed either for reduced traffic during off-peak hours or because of distortion in the telephone system.
Fall forward	Switching from a lower to a higher data rate.
Flow control	Controls data transfer between endpoints in a data network; line signals or flow control characters stop and start the flow of data.
Four-wire	A circuit containing two pairs of wires, one pair for each transmission direction.
Full-duplex	A signaling circuit that allows simultaneous 2-way transmission and reception.
Frame	A group of bits transmitted serially over a communications channel. The basic data transmission unit used with bit-oriented protocols.
Gain	The amount by which an amplifier (or power) increases the amplitude of a signal passing through it; often represented in dB.
Half-duplex	A circuit that allows alternating transmit and receive signals, but not both simultaneously.
HDLC	High-level data link control. ITU-specified, bit-oriented, data-link control protocol; any related control of data links by specified series of bits rather than by control characters.
Hexadecimal	Base 16 number system with digits ranging from 0 to F.
ITU. See CCITT	International Telecommunications Union. Formerly CCITT.
ITU -T	Telecommunication Standardization Sector of ITU.
ITU V.13	V.13 signaling allows your modem to communicate with non-Telenetics modems. This signaling operates when the modem is configured for synchronous mode.
ITU V.22 bis	2400 bps modem standard for use with dial and leased-line circuits.

ITU V.24	An electrical standard for interconnecting data communications equipment and data terminal equipment established by the ITU. It is the most commonly used computer/modem interface. Nearly equivalent to EIA/TIA 232-D.
ITU V.25 bis	An ITU-specified serial Auto-Call Unit (ACU) for operation with both asynchronous and synchronous DTE equipment.
ITU V.32	The standard for 2-wire, full-duplex modems operating at up to 9600 bps for use on the general switched telephone network and on leased telephone circuits.
ITU V.32 bis	A modulation standard that extends the speed of 2-wire leased line and 2-wire dial line modems to include 14.4 and 12.0 kbps. It is backwards-compatible with the V.32 modulation mode. When operating in the V.32 bis modulation mode, the modem supports synchronous and asynchronous transmission rates of 4.8, 7.2, 9.6, 12.0, and 14.4 kbps.
ITU V.42	Used with full-duplex asynchronous data transmission, V.42 is an ITU-adopted standard which specifies two methods of error correction for modems: MNP 4 and LAPM (Link Access Protocol for Modems).
ITU V.42 bis	Used with full-duplex asynchronous data transmission, V.42 bis is a high-performance data compression algorithm based on the Lempel-Ziv Data Compression algorithm. This compression technique is not compatible with MNP 5 or other MNP levels. The theoretical limit of V.42 bis is 4:1 compression. The actual compression (throughout) that is achieved with any algorithm, including V.42 bis is data (file) dependent. Using V.42 bis, the modem continuously monitors the compressibility of user data. If user data is not compressible, the V.42 bis algorithm detects this condition and automatically turns data compression off, so the data link rate is never less than the modem modulation rate.
ITU-TS V.34	V.34 is a four-dimensional trellis-coded modulation standard using precoding and pre-emphasis equalization schemes.
Interface	A shared connection or boundary between two devices or systems. The point (logical or physical) at which two devices or systems are linked.
LAPM	Link Access Protocol for Modems. An ITU link layer protocol for modems.
Leased line	A dedicated telephone-line circuit permanently connecting two or more locations and used solely by one customer, who leases the line.
LED	Light Emitting Diode.
Loopback	(1) A method of feeding a received signal back from a point in a data link to the receiver at the site where the data was originated. Commonly used to test portions of a data link to isolate faulty equipment or data lines. (2) The feeding back of data from a point in a data path to the transmitting source for testing. (3) A diagnostic procedure that sends a test message back to the originator, which compares the message with the original transmission. Loopback testing can occur within a locally attached device or can be conducted remotely over a communications circuit.
LPDA2	Feature that enables the 326X to be used in an IBM dial and leased line restoral applications using LPDA2 Dial and Disconnect commands.
Modem	Modulator/demodulator, enabling digital data to be sent over analog transmission facilities.

Modulation	Systematic changing of properties (e.g., amplitude, frequency, phase) of an analog signal to encode and convey digital information.
MNP	Microcom Networking Protocol. An asynchronous communications protocol that provides error correction.
Multiplexer	(1) Any multiport device that allows two or more users to share a common physical transmission channel; employed in pairs, one at each end of the channel, where each device performs both multiplexing of the multiple user inputs and demultiplexing of the channel back into the separate user data streams. (2) A device that allows two or more analog data signals to be transmitted simultaneously over a single telephone line.
Off-hook	The description for when a telephone or modem connects to the dial line and presents electrical characteristics, similar to when a telephone handset is removed from the cradle.
Parity bit	An error-checking mechanism for asynchronous transmission. An additional nondata bit added to a group of bits, that indicates whether the number of 1's in the group is odd or even.
PBX	Private branch exchange. A telephone switching system located on a customer's premises.
Phase jitter	The deviation in phase of the transmitted analog signal from its timing signal; often caused by alternating current components in a telecommunications network. It is continuous, long-term, and often nearly constant in frequency and severity.
Point-to-point	A line that directly connects two end points (e.g., a remote location to a host computer); opposite of multipoint.
Port	A connector and associated circuitry enabling digital data to be injected into or retrieved from a communications network.
Protocol	Formal set of rules governing the format, timing, sequencing, and error control of exchanged messages on a data network.
PSTN	Public Switched Telephone Network.
PTT	Postal Telegraph and Telephone. Government authority (in many European countries) that typically operates the public telecommunications network, sets standards and policies, and negotiates communications issues internationally for a particular country.
QAM	Quadrature Amplitude Modulation. A type of modulation that varies both the phase and amplitude of an analog wave.
RS-232-D	See EIA/TIA 232-D.
RTS	Request To Send. The signal from a terminal to its co-located modem that prepares the modem for data transmission.
SDC	See Synchronous Data Compression.
SDLC	Synchronous data link control; bit-oriented protocol developed by IBM.
Start bit	A data bit used in asynchronous transmission to signal the beginning of a character.
Stop bit	A data bit used in asynchronous transmission to signal the end of a character.
STX	Start of text control character. Designates the start of a message's text as well as (usually) the end of the message heading.

SYN	Sync character. Establishes synchronism and fills time in the absence of any data or control character to maintain synchronism.
Synchronous	Data accepted or provided with an accompanying time signal.
Synchronous Data compression (SDC)	An algorithm that allows the modem to run at a DTE rate higher than the DCE rate. This is accomplished by receiving frames of data at the originating end, compressing, and then transmitting the data at the slower DCE rate, and decompressing the data at the receiving side. The compression algorithm is derived from the V.42bis data compression algorithm. SDC only applies when synchronous data is framed in HDLC-SDLC-like format.
Tail circuit	A point-to-point, second-tier circuit directly connected (back to back) to the remote modem of the first-tier circuit. The connection is made using a DCE/DTE crossover cable.
Training	A technique that adjusts modems to current telephone line conditions. The transmitting modem sends a special training sequence to the receiving modem, which makes necessary adjustments for line conditions.
Transmission rate	Bits per second passing over the telephone line or other communications circuitry.
Two-wire	A circuit consisting of one pair of wires.
V.22bis	See ITU V.22bis.
V.24	See ITU V.24.
V.25bis	See ITU V.25bis.
V.32	See ITU V.32.
V.32bis	See ITU V.32bis.
V.34	See ITU-TS V.34.
V.42	See ITU V.42.
V.42bis	See ITU V.42bis.

Return Procedures

Contents

Equipment Return Procedures	2
Expiration of Lease	2
Factory Repair	2
Packaging Guidelines for Equipment Return	2

The following sections apply to U.S.A. customers only. Other customers with questions or concerns regarding return procedures should contact their Telenetics subsidiary or distributor.

Equipment Return Procedures

If you have questions about equipment return procedures, call your local distributor or call Telenetics at (949) 455-4000.

If you require on-site service or unit-exchange service, call your local distributor or call Telenetics at (949) 455-4000.

Expiration of Lease

To return equipment upon expiration of a lease agreement, contact Telenetics for return authorization and instructions. A list of these offices is available on the Telenetics website. When you contact the sales office, provide the following information:

- Product name and description
- Serial number
- Customer order number
- Reason for return

Factory Repair

To return equipment for factory repair, call Telenetics at (949) 455-4000 for return authorization and instructions. When you call, you will be given a Return Material Authorization (RMA) control number. Mark this number clearly on the shipping container for ease of identification and faster service. The RMA control number provides a convenient tracking reference for both parties. Please have the following information available for each piece of equipment you return:

- Product name and description
- Serial number
- Failure symptoms

Packaging Guidelines for Equipment Return

Data communications equipment or parts that are to be returned to Telenetics must be properly packaged to prevent damage in shipment and handling.

If the original packing material and shipping container are available, reuse these items to return equipment. If these items are not available, it is your responsibility to package the contents in a manner that protects the equipment from damage during normal shipping and handling. Responsibility for damage to equipment during transit must be resolved between you and the carrier. The Logistics Administration group can provide you with specific packaging instructions upon request.

Symbols

+++ (AT escape sequence) 5-5
 , 5-13
 <> 5-13
 = 3-5
 @ dial modifier 5-12

Numerics

35XX device 4-23

A

A/ 5-7
 A/B LED 3-4
 AC Detect (S-Register 98) 5-18
 Access security
 lead digit delay timeout (S-Register 46) 5-16
 tone duration (S-Register 45) 5-16
 Adaptive Rate System 1-9
 Adaptive rate system 1-9
 ALM LED 3-4
 Always= C-5
 APPC/APPN 4-19
 Application examples
 SDC 4-22
 V.32bis and V.34 4-21
 asynch data forma t3-2
 asynchronous host computer 4-16
 AT 5-3
 AT ACU
 configure and operate modem 3-8
 AT command set 5-2
 AT commands 1-8
 +++ (escape sequence) 5-5
 =x, Change S-Register Value 5-10
 ?, Display S-Register Value 5-10
 A, Manual Answer 5-7
 A/, Autobaud 5-5, 5-7
 and autobaud feature 5-5
 cross-referenced to front panel options A-2
 D, Dial 5-7
 entering 5-3
 errors in entry 5-4
 H, Hang Up 5-8
 I, Display Software Information 5-8
 O, Leave Command Mode 5-8
 result codes A-41
 Sn=x, Change S-Register Value 5-10
 Sn?, Display S-Register Value 5-9
 X, Call Progress 5-7
 Australia C-6

Austria C-6
 Auto Call Unit (ACU)
 LPDA-2 1-5
 V.25bis 1-5
 Autobaud 5-5
 Autobaud feature 5-5
 automatic call units (ACUs) 1-2
 Automode/multimode feature 1-7
 Avertissement xvi

B

BABT regulations
 Hong Kong C-32
 backplanes 2-5
 Backspace character (S-Register 5) 5-12
 bandwidth on deman d4-16
 Belgium C-6
 Bell 801C ACU 3-10
 Besondere Hinweise
 Beschreibung xvi
 Blind dialing
 Denmark C-32
 blind dialin g5-12
 bridge 4-16
 British Telecom C-36
 Buffer delay
 during disconnec t5-16
 bulletin board 4-16
 BUSY message A-41
 busy out 5-8, A-44

C

cables 2-4
 Cabling
 daisy-chain 2-13
 NMS 2-13
 Cabling overview
 Figure 2-5 3260/6 52-12
 Figure 2-6 3261/6 62-12
 Call establishment methods 3-10
 Call progress
 and the ATD command 5-7
 Canada C-6, C-28
 card modem 2-2
 card modems in enclosure 2-14
 Carrier loss hang up delay (S-Register 10) 5-13
 central site 4-16
 change S-Register value 5-10
 Character formats
 for autobaud 5-5

- ci rcuit quality monitoring system (CQMS) 1-8
- cluster controller 4-16
- COM port 6-2
- command line 5-4
- Command mode
 - leaving 5-8
- command mode 5-3
- communications software e3-9, 4-2, 5-2, 6-2
- Communications software, equipment needed 2-4
- computer connectors 2-5
- Configuration options
 - selecting from front panel 3-5
- Configuration options list A-2
- configure a modem 5-3
- configure and operate the modem 3-2
- CONNECT 1200 message A-41
- connector pinouts B-6
- Connectors 2-5
- country regulatory agencies 1-9
- Czech Republic C-7

D

- data carrier 5-13
- data compression A-43
- data encoding 4-21
- data format 3-2
- Data rates 1-6
- default (defined) 3-5
- Defaults
 - front panel, option sets 3-5
 - option sets 4-11
- Delay before looking for DTR (S-Register 25) 5-15
- delayed/forbidden lists C-23
- Denmark C-7
- Diagnostic tests 6-10
- Dial line jack types
 - United States of America C-38
- Dial modifiers A-39
- dial wait modifier 5-12
- Dialing
 - from keyboard 5-7
- dialing and storing numbers 5-2
- dialing into a LAN 4-16
- digital interface B-2
- DIP switches 2-5
- Direct mode 5-13
- Disconnect buffer delay (S-Register 38) 5-16
- displaying S-register value 5-9
- DOC
 - requirements C-28
- DTE connectors 2-5
- DTE inactivity disconnect (S-Register 30) 5-15
- DTE port 4-18
- DTE rates 1-6

Index-2

- DTMF tone duration (S-Register 11) 5-14
- DTR delay 5-15

E

- efficiency 4-21
- EIA/TIA 232-D interface 2-6
- EIA/TIA 232-D interface specification B-2
- electrical interface 6-2
- Electrical interfaces 2-6
- enclosure card modems 2-14
- enclosure cards 1-2
- encoding 4-21
- entering data on the front pane 1A-37
- equipment damage 2-3
- Error correction and data compression feature s1-8
- ERROR message A-41
- error messages 2-15
- Error messages, self-test 2-15
- Escape code character (S-Register 2)5-11
- Escape code guard time (S-Register 12)5-14
- escape mode 5-3
- Escape sequence (+++) 5-5
- Example
 - Accessing a Configuration Option 3-6
- Examples
 - V.32bis and V.34 4-16
- exiting command mode 5-8
- external dialer 3-11

F

- FCC Registratio nC-36
- FCC regulations C-37
- ferrite cylinders 2-7
- filters 2-7
- Finland C-7
- flow control 4-17, 4-19
- frames 4-21
- France C-7
- front end processo r4-16
- Front panel 3-2
 - configuration option sA-2
 - options, defaults 3-5

G

- Germany C-8
- grounding 2-11
- Guard time 5-6

H

- hang u p5-8
- HDLC/SDLC 4-21
- Hong Kong C-8, C-32
- host computer 4-16

I

IBM AS 400 3-10, 4-16, 4-19
initialization strings C-12
initiate and terminate test s6-10
INITIATING RC message A-41
Installation
 connecting a telephone to modem C-41
 ferrite cylinder 2-7
 setting DIP switch A-44
 site selection 2-4
Interfaces
 digital B-2
 LEASE LINE B-6
 PHONE B-7
Ireland C-8
Israel C-8
Italy C-9
ITU recommendation V.35 B-4
ITU V.35 interfac e2-6
ITU-TS
 V.34 modulation 1-6

J

jack type C-42
Jack types
 Canada C-29
 United States of America C-38
jacks 2-5
Japan C-9

K

k 5-13
Keys, front panel 3-5
Keys, how to use 3-5

L

LAPM A-43
LCD 3-2
LEDs 3-2
Line feed character (S-Register 4) 5-11
line filters 2-7
Link Problem Determination Aid (LPDA-2)
 LPDA-2 3-10
link utilization n4-21
liquid-crystal display 1-2
Loopback tests 6-10
LPDA2 1-5

M

Malaysia C-9
manual answering 5-7
manual dialing
 using the ATD command 5-7

Menu tree
 navigating 3-5
Message, self-test 2-15
messages 2-15
Messages spéciaux xvi
 Important xvi
Mise en gard exvi
MNP A-43
MNP-5 A-43
modem card 2-2
Modular Nest enclosure 1-2, 2-7

N

NC IN and NC OUT connectors 2-13
NC IN and NC OUT ports 2-5
NC port pinouts B-6
Netherlands C-9
NetView LPDA-2 ACU 3-10
network configuration 4-2
Network Control Port
 connector pinouts B-7
Network management 1-6
Network management cables 2-7
NETWORK MANAGEMENT INHIBITED
 message A-41
network management system 1-2
network performanc e1-8
NO ANSWER messag eA-41
NO CARRIER message A-41
NO DIALTONE messag eA-41
Normal mode 5-13
Norway C-10
NRZ/NRZI 4-21
Numeric entry A-37

O

OK message A-41
operation problems 6-2
optimizing network performance 4-21
option set 3-5
Option Set 1, SDC (async calls to central site) 4-8
Option Set 2 - Sync Answering Central Site 4-7
Option Set 2, SDC (sync dial A/B restoral) 4-9
Option Set 3 - Sync Calls to Central Site 4-7
Option Set 4 (async answering at central site) 4-8
option sets 1-5
options 3-5

P

parameters 3-5
PASSWORD PROTECTED message A-41
password protection A-45
Pause delay dial modifiers (S-Register 8) 5-13

PHONE

connector pinouts [B-7](#)

Pinouts

EIA/TIA 232-D [B-2](#)

interface

3260/65 [C-18](#)

3261/66 [C-19](#)

3262/67 [C-22](#)

3263/68 [C-22](#)

ITU V.35 recommendatio [nB-5](#)

LEASE LINE [B-6](#)

NC (Network Control) port [B-7](#)

PHONE [B-7](#)

pinouts [C-39](#)

Poland [C-7](#)

Portugal [C-10](#)

Postscript number [5-4](#)

power cable [2-7](#), [2-9](#), [2-14](#)

power connectors [2-5](#)

R

RC ABORTED message [A-41](#)

RC COMPLETE messag [eA-41](#)

RC DENIED message [A-41](#)

RC ESTABLISHED message [A-41](#)

RC FAILED message [A-41](#)

RC NOT AVAILABLE message [A-41](#)

RC SESSION IN PROGRESS message [A-41](#)

RC/NC LED [3-4](#)

Re [5-6](#)

rear panel views [C-12](#)

redial attempts [C-23](#)

Redialing

last number [5-9](#)

Re-executing AT command (A/) [5-7](#)

regulations [1-9](#), [2-2](#)

Reinitializing the modem [4-5](#)

Reliable connection

AT messages [5-5](#)

Reliable mode [5-13](#)

Remote Access Reset [4-28](#)

remote configuratio [n5-8](#), [A-45](#)

REN [C-33](#), [C-36](#)

restoral [4-9](#), [4-16](#), [4-20](#), [4-22](#), [C-16](#)

restricted commands [C-12](#)

restricted features [C-5](#)

Result codes

AT, word form [A-41](#)

Return character (S-Register 3) [5-11](#)

RFI and ferrite cylinder [2-7](#)

Ring count (S-Register 1) [5-11](#)

Ring count to answer on (S-Register 0) [5-10](#)

RING message [A-41](#)

Rockwell-based modems [5-18](#)

router [4-16](#)

RTS/CTS delay (S-Register 26) [5-15](#)

S

SDC

configuring [4-22](#)

operational requirements [4-21](#)

pre-operation note [s4-21](#)

SDC tests [6-11](#)

Security features [1-8](#)

self-test [2-15](#)

Serial cable

equipment needed [2-4](#)

Site selection [2-4](#)

Software information

displaying using the ATI command [5-8](#)

South Africa [C-10](#)

Spain [C-10](#)

Specifications

interfaces

ITU V.35 (modem to computer) [B-5](#)

NC port [B-7](#)

PHONE [B-7](#)

S-Register

04 (Line Feed Character) [5-11](#)

S-Registers

00 (ring count to answer on) [5-7](#), [5-10](#)

01 (ring) [5-11](#)

02 (Escape code character) [5-11](#)

03 (Carriage Return Character) [5-11](#)

05 (backspace character) [5-12](#)

06 (Wait for Dial Tone) [5-12](#)

07 (Wait for data carrier) [5-12](#)

08 (Pause delay dial modifiers) [5-13](#)

10 (Carrier loss hang-up delay) [5-13](#)

11 (DTMF tone duration) [5-14](#)

12 (Escape code guard time) [5-14](#)

12 (escape sequence guard time) [5-6](#)

18 (Test Time) [5-14](#)

25 (DTR Delay) [5-15](#)

26 (RTS/CTS delay) [5-15](#)

30 (DTE Inactivity Disconnect) [5-15](#)

38 (Disconnect buffer delay) [5-16](#)

45 (Access security tone duration) [5-16](#)

46 (access security lead digit delay timeout) [5-16](#)

98 (AC Detect) [5-18](#)

changing values

with the AT=x command [5-10](#)

cross-referenced to AT commands and front panel options [A-38](#)

displaying value [5-9](#)

AT? command [5-10](#)

standalone modems [1-2](#)

Standalone rear panel view
 model 3261 [C-13](#)
 model 3265 [C-14](#), [C-15](#)
 model 3266 [C-16](#)
Status snapshots [1-8](#)
Sweden [C-11](#)
Switzerland [C-11](#)
synch data format [3-2](#)
Synchronous data compression (SDC) [1-7](#)

T

Talk/data switch [3-6](#)
Telenetics extended AT command set [1-5](#)
Telenetics offices [2-3](#)
Telenetics website [2-3](#)
telephone book [1-5](#)
telephone connection to modem [C-41](#)
terminal server [4-16](#)
Test timer (S-Register 18) [5-14](#)
Tests
 Modem Diagnostic [6-10](#)
tests [1-9](#), [6-10](#), [A-44](#)
Tests, automatic self-test [2-15](#)
Tests, SDC [6-11](#)
timing [4-18](#), [4-23](#), [5-4](#)
TR LED [3-4](#)
training sequence [5-18](#)
Troubleshooting
 overview [6-2](#)
 RFI [2-7](#)
 V.54 and V.22bis tests [1-9](#)
Troubleshooting Guide (table) [6-3](#)

U

UNDER RMT CONFIG message [eA-41](#)
United Kingdom [C-11](#), [C-32](#)
Universal [C-11](#)
UNIX workstation [4-16](#)
Unpacking the modem [2-3](#)

V

V.25bis ACU [3-10](#)
V.34 modulation [1-6](#)
V.34 operation and cabling [2-6](#)
V.35 electrical interface [A-44](#)
V.35 interface [B-4](#), [B-6](#)
V.42bis [A-43](#)
Vorsichtshinweis, Beschreibung [xvi](#)

W

w dial modifier [5-12](#)
Wait for data carrier (S-Register 7) [5-12](#)
Wait for dial tone (S-Register 6) [5-12](#)

Warnhinweis, Beschreibung [xvi](#)
Warning statement
 connecting ports [C-4](#)
website [2-3](#)
WICHTIG-Hinweis, Beschreibung [xvi](#)
window sizes [4-21](#)

X

X.25 network [4-16](#)
X.25 node [4-16](#)

